



PM-50 Digital Meter User Manual

LP1147 | January 2022

Firmware Version 1.2.6 or higher

COPYRIGHT

©2021 Red Lion Controls, Inc. All rights reserved. Red Lion and the Red Lion logo are registered trademarks of Red Lion Controls, Inc. All other company and product names are trademarks of their respective owners.

Red Lion Controls, Inc.
20 Willow Springs Circle
York, PA 17406

Table of Contents

Programming the PM-50

Programming Methods

Programming Wizard

Wi-Fi Setup and Remote Access:

Wi-Fi Status

How to connect to the PM-50 Wi-Fi Client

How to connect to the PM-50 Wi-Fi Access Point

Wi-Fi Notes

Update Firmware

Programming Wizard

Initial Setup Wizard

Quick Setup

Device Configuration

Main Display Icon Descriptions

Display Configuration

Network Configuration

Account Configuration

Signal Input Configuration

SP & Analog Configuration

Function Configuration

Modbus Configuration

Misc. Configuration

Hardware Setup

Specifications

Dimensions In inches (mm)

Installation Environment

Ordering Information

Accessories

Meter Installation

Adding Modules

To a 4.3 inch Host

Module Installation Variations for 4.3 Inch (1/8 DIN) PM-50

To a 3.5 inch Host

Wiring

Power Wiring

Service and Support Information

Service Information

Product Support

Limited Warranty

Programming the PM-50

Programming Methods

There are several methods to program a PM-50. On first power up, there is a default configuration that allows you to configure using the Initial Setup Wizard (also referred to as Programming Wizard). The Wizard has two options:

Quick Setup - This method allows you to manually configure the basic setup for Screen, Input, Output and Wi-Fi. After the configuration setup, you are directed to the HOME screen of the device.

Import Configuration - This method allows you to import a config.txt file from the microSD card. This file can be exported from another PM-50. Essentially cloning that device.

After the Initial Setup Wizard, additional touch screen programming or changes can be done by touching the Top right corner icon  called Configuration. You can also access the device configuration remotely. For remote access, you must first setup the Wi-Fi access. Once Wi-Fi is enabled, you can program remotely using web interface or mobile app (Android and iOS). It is also possible to import a config.txt file saved from another PM-50 using these remote means. An explanation of each of these methods follows.

Note: The device allows programming either using the touchscreen or remotely.

Programming Wizard

The Programming Wizard is the initial Device Setup Wizard which appears automatically:

- when the device boots for the first time or,
- when Factory Reset is enabled

The Programming Wizard can also be manually triggered by following these steps:

1. Login as the Admin user using the touchscreen
2. Go to  (Device) → Misc. Configuration → Factory Configuration → Enable Programming Wizard and set the switch to ON.
3. Click the Apply & Exit button, or continue on to the next pages and click the Apply button on the final page.
4. At the next power cycle or reboot, the Programming Wizard will start.
5. After exiting the Programming Wizard, it will automatically disable.

Note: Enable Programming Wizard cannot be enabled remotely using Wi-Fi through a web browser or through the Mobile app.

The complete Programming Wizard setup details can be found [here](#).

Wi-Fi Setup and Remote Access:

The Wi-Fi setup can be done during the Initial Setup Wizard, by importing the configuration from another device, or using the Quick Setup section.

Note: The Admin password must be enabled for Wi-Fi setup to be accessed.

1. If not using the Wizard or importing the configuration then, login to the device as the Admin user using the touchscreen.
2. Go to  [System Configuration](#) → [Network Configuration](#) → [Wi-Fi Configuration](#)
 - a. Set Enable Wi-Fi to ON and click the right navigation arrow.
 - b. If the Admin Password is configured already, then the next page will be Wi-Fi Connection Mode. Else “Set Admin Password” page will be loaded to configure the Admin password and proceed.
3. Set the Wi-Fi Connection Mode to Client or Access Point based on the remote connection requirement as follows:

Client Mode:

- In Client Mode, set Enable DHCP Client to ON and the connected running DHCP Server will assign the IP information. Otherwise, set Enable DHCP Client to OFF, then click on the right navigation arrow and setup the IP Address, Subnet Mask and Gateway.
- Configure the Access Point SSID and Password to connect to the network for remote access.

Access Point:

- In Access Point mode, set Enable DHCP Server to ON if the user has to get the IP assigned automatically when they connect to the device’s Access Point.
- When Enable DHCP Server is ON, the user has to setup the IP Address, Subnet Mask, Gateway, Starting Address, and Ending Address.
- The Starting and Ending Addresses are used by the DHCP Server to assign a range of IP addresses allowed to connect to the PM-50.
- If Enable DHCP Server is OFF, then the user has to setup the IP Address, Subnet Mask and Gateway.
- Set the Encryption Mode based on the Access Point encryption requirement

4. Once the Wi-Fi Configuration setup is complete, turn Enable Modbus/TCP over Wi-Fi ON or OFF based on the necessary requirements. (This is not in the Wizard.)
5. Click the Apply button on the final page to configure the Wi-Fi settings.

Wi-Fi Status

The Menu bar should load with the Wi-Fi Icon after returning to the main display. There are two methods to check the status of the Wi-Fi:

1. Return to the configuration mode and click the Wi-Fi Icon in the menu bar. A page will load with the device IP details.
2. Go to  [Device](#) → [Misc. Configuration](#) → [About this Device](#) and click the right navigation arrow to go to the Network Configuration section.

<On Successful configuration>

IP Info: (AP) https://xxx.xxx.x.xx (your IP address)

Subnet Mask: 255.255.255.0

Gateway: 192.168.1.1

Wi-Fi Status: Cfg Success, AP 1 devices

<On connection failure with invalid SSID or password>

IP Info: (No Wi-Fi) 0.0.0.0

Wi-Fi Status: Cfg Success, Disconnected

<On configuration failure with Wi-Fi setup>

IP Info: (No Wi-Fi) 0.0.0.0

Wi-Fi Status: Configuration Failed

<On Wi-Fi setup is not initialized>

IP Info: (No Wi-Fi) 0.0.0.0

Wi-Fi Status: Cfg not initialized

The Network Configuration section provides the Wi-Fi configuration details with its IP Information or any connection issue.

Once the Wi-Fi Setup is successful with the IP assigned to the device and your PC/Mobile is connected, based on the “Wi-Fi communication mode”, follow the steps below to access the device configuration.

How to connect to the PM-50 Wi-Fi Client

1. Once the PM-50 is configured in Client mode successfully, the Wi-Fi icon will appear. Connect the PC/Mobile to the same network with the SSID and password.
2. To view the Wi-Fi configuration status with the IP details, click the Wi-Fi Icon in the menu bar while in Configuration mode, or go to  [Device](#) → [Misc. Configuration](#) → [About this Device](#). Then click the

right navigation arrow to access the Network Information section.

<On Successful configuration>

IP Info: (AP) https://xxx.xxx.x.xx (your IP address)

Subnet Mask: 255.255.255.0

Gateway: 192.168.1.1

Wi-Fi Status: Cfg Success, Connected

3. Open a web browser (Chrome, FireFox, Safari etc) or the Mobile App and enter “https://xxx.xxx.x.xx (your IP address)” to connect to the PM-50.

Note: You must be logged out of Configuration Mode on the device to log into configuration using Wi-Fi.

How to connect to the PM-50 Wi-Fi Access Point

1. Once the PM-50 has been configured in Access Point mode successfully, enable the Wi-Fi mode on your device and search for the SSID configured in the device.
2. Select the SSID and connect with the given password.
3. To check the connection status with the IP details from the PM-50, click the Wi-Fi Icon in the menu bar, or go to  [Device](#) → [Misc. Configuration](#) → [About this Device](#). Then click the right navigation arrow to go to the Network Information section to view the Wi-Fi configuration status.

<On Successful configuration>

IP Info: (AP) https://xxx.xxx.x.xx (your IP address)

Subnet Mask: 255.255.255.0

Gateway: 192.168.1.1

Wi-Fi Status: Cfg Success, AP 1 devices

4. Open a web browser (Chrome, FireFox, Safari etc) or the Mobile App and enter “https://xxx.xxx.x.xx (your IP address)” to connect to the PM-50.

Note: You must be logged out of Configuration Mode on the device to log into configuration using Wi-Fi.

Wi-Fi Notes

Presently, Wi-Fi is only for real time viewing and configuration of the PM-50. With DHCP Client enabled (On), it is possible for the IP address to be dynamically changed by the server. There are only a few parameters that you cannot configure through Wi-Fi. There is a small delay to real time data update.

Update Firmware

The PM-50 allows you to update the firmware using the microSD card or remotely from a web browser with Wi-Fi enabled. It is strongly suggested that the configuration in the PM-50 be saved to a config.txt file using a microSD card or through Wi-Fi before updating to a new firmware version.

Update Firmware Using microSD Card

The microSD card can be used to flash (install) new firmware onto the PM-50 by placing an image file (gpmcore.fwb) on the formatted microSD card. The microSD card should be 32 GB or smaller in size and formatted with the FAT16 or FAT32 format for the firmware update from microSD to work. Follow the steps below to flash new firmware onto the device.

1. Ensure the device is powered off and insert the microSD card loaded with the latest firmware into the microSD card slot in the device.
2. Power on the device and click the gear icon to login as the Admin User.
3. If you see the programming wizard, complete the initial setup or click the Exit button and complete the initial setup after the new firmware is installed.
4. Once the programming wizard updates are completed, login to the device with Admin user credentials.
5. Go to  [Device](#) → [Misc. Configuration](#) → [Firmware Upload](#)
6. The Firmware Upload page shows the microSD card status with the version of the firmware on it.

Note: If it shows “No SD Card”, “No Firmware in SD Card” or “Invalid FW in SD Card”, check the firmware name (gpmcore.fwb) and microSD Card size, then repeat steps 1 through 5.

7. Click the Upload button to upgrade to the new firmware.
 - The next page loads to show the Firmware Upload progress details. At the completion of the upload, the unit will proceed with reboot.
 - After the PM-50 reboots, The PM-50 will momentarily display the upgraded firmware version in the lower left screen area. The firmware version can also be verified at  [Device](#) → [Misc. Configuration](#) → [About this Device](#). User settings from the previous firmware should be retained.

Upgrade Firmware Remotely

The firmware of the PM-50 can be upgraded remotely from a web browser once Wi-Fi access is enabled.

1. Login to the device remotely from a web browser or through the Mobile App.
2. Go to  [Device](#) → [Misc. Configuration](#) → [Firmware Upload](#)
3. Click the Select file button, select the firmware file (gpmcore.fwb) to upgrade to and click the [Upgrade](#) button.
4. A pop-up window warns that the firmware upgrade will reboot the device. Click on [Proceed](#) to start the firmware upgrade procedure and the PM-50 will show the upgrade status and then reboot. User settings from the previous firmware should be retained. You may lose Wi-Fi connection during reboot.
5. The PM-50 will momentarily display the upgraded firmware version in the lower left screen area.

Programming Wizard

The Programming Wizard is not available through Wi-Fi using a web browser or through the Mobile app.

Initial Setup Wizard

Select an Option to Continue
Quick Setup
Import Configuration
Exit

Quick Setup

Programming Wizard
Screen
Input
Output
Wi-Fi
Exit

From here, you have access to select the basic parameters you want to program without going through the entire configuration sequence.

For more detailed programming information for the menus, select the menu below:

[System](#) - Display Configuration, Network Configuration and Account Configuration

[Device](#) - Inputs, Output, Function Keys and User Inputs, Modbus, and Misc Configurations

[Home Screen](#) - Screen Configuration

Items outlined in this color indicate programming wizard.

Programming Wizard Screen

Screen	Screen Number
	1 <input checked="" type="radio"/>
	2 <input type="radio"/>
	3 <input type="radio"/>
	4 <input type="radio"/>

Select which screen you would like to configure. Screen 1 shown.

Screen (1)	Display Style
	None <input checked="" type="radio"/>
	Gauge <input type="radio"/>
	Setpoint Status <input type="radio"/>
	Numeric <input type="radio"/>
	Max Min Total Monitor <input type="radio"/>

Items outlined in this color indicate programming wizard.

If you select Setpoint Status for your display, the next menu you see will be:

Output Type

Setpoint 1

Setpoint 2

If you have a Dual or Quad Relay module installed, you will see additional Setpoints (up to 6). Select which setpoint statuses you want to see on the screen.

Apply settings
Save or cancel changes

Apply Cancel

For Display Styles other than Setpoint Status, you will see a combination of the following menus. Not all parameters are available for each of the different styles.

Signal Type

Counter

Rate

If the Signal Type chosen is Counter:

Counter Type
Select Multiple to Scroll

Counter A

Counter B

Counter C

Items outlined in this color indicate programming wizard.

Unit for Counter A

units

The Unit for Counter selection will repeat for each counter selected in the previous step.

If the Display Style is set for Gauge, the following two selections are shown. These values are for graphical display units and are not the calculated Rate minimum and maximum values.

Minimum Display Value

0

Maximum Display Value

200

Apply settings

Save or cancel changes

Apply

Cancel

Items outlined in this color indicate programming wizard.

If the Signal Type chosen is Rate:

Signal Type

Counter



Rate



Rate Type

Select Multiple to Scroll

Rate A

Rate B

Rate C

Hi

Lo

Unit for Rate A

units

The unit for Rate selection will repeat for each Rate Type selected in the previous step.

If the Display Style is set for Gauge, the following two selections are shown. These values are for graphical display units and are not the calculated Rate minimum and maximum values.

Minimum Display Value

0

Items outlined in this color indicate programming wizard.

Maximum Display Value

200

Apply settings

Save or cancel changes

Apply

Cancel

Items outlined in this color indicate programming wizard.

Once back at the main Programming Wizard menu, you can choose to setup the Input, Output, Wi-Fi or Exit. All of the options are shown here. The options you see will depend on the selections you make as you step through the programming.

Programming Wizard

Input

Device / Signal Input

Counter Configuration

Rate Configuration

Counter Configuration

Counter

Counter A



Counter B



Counter C



Operating Mode Counter

Counter A selections:

None

Count x1

Count x1 w/ Direction

Dual Count x1 w/ Direction

Dual Count x1 Add/Add

Items outlined in this color indicate programming wizard.

Operating Mode Counter

Counter A selections: (Cont'd)

Dual Count x1 Add/Subtract

Quadrature x1

Quadrature x2

Quadrature x4

Dual Count Quadrature x1

Dual Count Quadrature x2

Count x2

Count x2 w/ Direction

Dual Count x2 w/ Direction

Counter B selections:

None

Batch

Count x1

Dual Count x1 w/ Direction

Dual Count Quadrature x1

Dual Count Quadrature x2

Count x2

Dual Count x2 w/ Direction

Counter C selections:

None

Counter A

Counter B

Counter A + Counter B

Items outlined in this color indicate programming wizard.

Counter C selections: (Cont'd)

Counter A - Counter B

Batch

Serial Slave

If Counter B or Counter C Operating Mode is set for Batch, the Next selection is:

Batch Source

Setpoint 1

Setpoint 2

If you have a Dual or Quad Relay module installed, you will see additional Setpoints (up to 6).

Decimal Point

0



0.0



0.00



0.000



0.0000



0.00000



Scale Factor for List A

Scale Factor Range (0.00001 to 9.99999)

1.00000

Items outlined in this color indicate programming wizard.

Count Load for List A

Range: -999999 to 999999

Scale Multiplier

- 0.01
- 0.1
- 1
- 10

Reset Action

- Zero
- Count Load

Reset At Power-Up

- No
- Yes

Apply settings

Save or cancel changes

Apply

Cancel

Items outlined in this color indicate programming wizard.

Rate Configuration

Rate Type	
Rate A	<input checked="" type="radio"/>
Rate B	<input checked="" type="radio"/>
Rate C	<input checked="" type="radio"/>
Common	<input checked="" type="radio"/>

Enable Rate
<input checked="" type="checkbox"/>

If Enable Rate is OFF, then the next page is Apply settings.

Rate A and Rate B

Decimal Point	
0	<input checked="" type="radio"/>
0.0	<input checked="" type="radio"/>
0.00	<input checked="" type="radio"/>
0.000	<input checked="" type="radio"/>
0.0000	<input checked="" type="radio"/>

Items outlined in this color indicate programming wizard.

Scaling Type

Enter Values



Apply Signal



Scaling Points

2

3

4

5

6

7

8

9

10

Click [here](#) for more information on scaling rate inputs.

Scaling Point 1

Range: 0.0 to 99999.9

0.0

If Apply Signal method is chosen, **Read Input** and **Save Input** buttons to read the Input and then save the value will follow each scaling point.

Items outlined in this color indicate programming wizard.

Display Point 1

Range: 0 to 999999

Scaling Point 2

Range: 0.0 to 99999.9

Display Point 2

Range: 0 to 999999

Repeats for each successive pair.

Display Rounding

1

2

5

10

20

50

100

Items outlined in this color indicate programming wizard.

Low Cut Out

Range: 0 to 999999

Apply settings

Save or cancel changes

Apply

Cancel

Rate C

Rate C Parameters

None

Sum (A+B)

Difference (A-B)

Percent Ratio (A/B)

Percent of Total $A/(A+B)$

Percent Ratio $(A-B)/B$

Items outlined in this color indicate programming wizard.

Decimal Point

0	<input type="radio"/>
0.0	<input type="radio"/>
0.00	<input type="radio"/>
0.000	<input type="radio"/>
0.0000	<input type="radio"/>

Rate C Multiplier

1	<input type="radio"/>
10	<input type="radio"/>
100	<input type="radio"/>
1000	<input type="radio"/>

Apply settings
Save or cancel changes

Items outlined in this color indicate programming wizard.

Common

Rate Low Update Time

Range: 0.1 to 999.9 Sec

Rate High Update Time

Range: 0.2 to 999.9 Sec

Maximum Capture Value Assignment

Rate A



Rate B



Rate C



Maximum Capture Delay Time

Range: 0.0 to 999.9 Sec

Items outlined in this color indicate programming wizard.

Minimum Capture Value Assignment

Rate A



Rate B



Rate C



Minimum Capture Delay Time

Range: 0.0 to 999.9 Sec

Apply settings

Save or cancel changes

Apply

Cancel

Items outlined in this color indicate programming wizard.

Programming Wizard

Output

Device / Setpoint

Setpoint Number

Setpoint 1

Setpoint 2

Setpoints 3 to 6 will show based on the Dual Relay (Setpoint 3-4) or Quad Relay (Setpoint 3-6) module installed.

Device / Setpoint (1)

Setpoint Assignment

None

Counter A

Counter B

Counter C

Rate A

Rate B

Rate C

If the Setpoint Assignment is None, then the next page is Apply settings.

Items outlined in this color indicate programming wizard.

Setpoint Action

- No
- Latched
- Timed Out
- Boundary

The following menus will vary depending on the Setpoint Assignment and Setpoint Action selected.

Output Logic

- Normal
- Reverse

Configure List A/B

- List A Config
- List B Config

Setpoint Value for List A

Range: -199999 to 999999

Items outlined in this color indicate programming wizard.

Setpoint Tracking

No

Setpoint 1

Setpoint 2

Setpoint 3

Setpoint 4

Setpoint 5

Setpoint 6

CLd A

CLd B

CLd C

Output Power-Up State

Off



On



Save



Counter Auto Reset

None



Zero at Start Activation



Count Load at Start Activation



Zero at End Activation



Count Load at End Activation



Items outlined in this color indicate programming wizard.

Output Reset with Count Reset

No

Yes

Output Reset at Sn + 1

No

Sn-Str

Sn-End

Activation Boundary Type

High Acting

Low Acting

Hysteresis

Range: 0 to 5999

Items outlined in this color indicate programming wizard.

Output Timed Out

Range: 0.0 to 599.9 Sec

1.00

Rate Timed Output One-Shot

No



Yes



Apply settings

Save or cancel changes

Apply

Cancel

Items outlined in this color indicate programming wizard.

Programming Wizard Wi-Fi

Network / **Wi-Fi**

Enable Wi-Fi



**Disables the Wi-Fi/Remote
operations**

Network / **Wi-Fi**

Enable Wi-Fi



**To use Wi-Fi, Admin
Password should be enabled**

Caution: There is no default password to unlock your unit if you forget the password you have entered. Make sure to place a copy of your password in a secure location to ensure you are not locked out. Once you hit Confirm, you will not be able to see or retrieve the password you entered.

System / **Account**

Set Admin Password

Enter New Password for Admin

Items outlined in this color indicate programming wizard.

System / Account

Set Admin Password

Enter New Password for Admin

Click to Re-enter and Confirm Password

System / Account

Set Admin Password

Re-Enter New Password for Admin

System / Account

Set Admin Password

Re-Enter New Password for Admin

Password Match. Confirm to proceed

Ignore

Confirm

Items outlined in this color indicate programming wizard.

Network / Wi-Fi

SSID

Network / Wi-Fi

Password

After setting your Wi-Fi password, the following menu will appear. After making your selection it will return you to the Programming Wizard main menu.

Apply settings

Save or cancel changes

Apply

Cancel

Items outlined in this color indicate programming wizard.

Import Configuration

Misc. / Import/Export
Import Config from SD Card

Filename

Import

Status:

The file name must be config.txt for a successful import.

When you click the import button, one of the following status messages will appear based on the microSD card:

- No SD Card detected - when the microSD card is not available in the slot, or the microSD card is an incompatible size or format
- File not found - If the microSD card is present, but the config.txt file does not exist
- Import successful, Rebooting - When the config.txt file is imported successfully, the device reboots to activate the configuration

Exit

If you select the Exit option from the Initial Setup Wizard Menu, the following menu appears.

Initial Setup Complete

Exit **Start Over**

Items outlined in this color indicate programming wizard.

Device Configuration

If you choose to skip the Quick Setup Programming Wizard, or did not enter a previous password, then the first time that you press the  icon you will see:

System / Account

Enable Admin Password

ON

Security Enabled

It is recommended to set an admin password to make the configuration secure. Make sure to remember your password. To maintain security, there is no default password to enter if you forget.

System / Account

Set Admin Password

Enter New Password for Admin

System / Account

Set Admin Password

Enter New Password for Admin

[Click to Re-enter and Confirm Password](#)

System / Account

Set Admin Password

Re-Enter New Password for Admin

System / Account

Set Admin Password

Re-Enter New Password for Admin







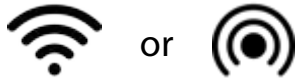
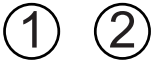

Password match. Confirm to proceed

Ignore

Confirm

Pressing the confirm button displays the main device configuration menu page. From here you can choose from the [System](#), [Device](#) or [Home Screen](#) icons to determine the section of the device you would like to configure.

Main Display Icon Descriptions

	<p>Top left company logo returns you to the main display.</p>
	<p>Wi-Fi icons - The left icon indicates connection to network, the right icon indicates access point mode is enabled. Press from the Home screen to check Wi-Fi settings.</p>
	<p>Setpoint 1 & 2 Status. Status of other setpoints must be viewed using the setpoint widget.</p>
	<p>Help Icon - This takes you to the on-line manuals.</p>
	<p>Indicates when the Admin is logged in. The A icon can also indicate that the Configuration mode is not protected with a password. Note: If there is no user action/touch for 10 minutes, the device will automatically logout from Admin mode.</p>
	<p>Top right gear icon takes you into the System Configuration menu page.</p>
	<p>The Home icon returns the user to the main display. This will not log you out of Configuration mode.</p>
	<p>The Configuration icon allows you to access the Display, Network, and Account Configurations.</p>
	<p>The Device icon allows you to access the Signal Input, Setpoint, Function, Modbus, Analog Out, Calibration and Misc. Configurations.</p>
	<p>This icon allows you to access the Home Screen Configuration.</p>



System

Display Configuration

Brightness & Sleep Timer



Update Display

Network Configuration

Wi-Fi



Set up Wireless Network

Account Configuration

User Access



User Account

Display Configuration

System / Display

Display Configuration

Display Brightness



Enable Sleep Timer



Default setting is OFF. This setting is the amount of time before the display goes dim if there is no screen touch.

Sleep Timer

Range: 1 to 3600 seconds

200

Display will dim after 200 Sec

Dark Theme

Power Save Mode



Power save mode when turned ON, will turn the background to Black. Off will turn the background to white.

Apply settings

Save or cancel changes

Apply

Cancel

Network Configuration

System / Network

Wi-Fi Configuration

Network / Wi-Fi

Enable Wi-Fi

ON

To use Wi-Fi, Admin Password should be enabled

When set to OFF, Wi-Fi and Remote operations are disabled. If switch is set to OFF, the next menu you see will be to apply or cancel changes. The below menus are enabled if the switch is set to ON.

Set Admin Password

Enter New Password for Admin

If you previously entered a password, the password parameters will be skipped. You must enter a new password to proceed.

Caution: There is no default password to unlock your unit if you forget the password you have entered.

Make sure to place a copy of your password in a secure location to ensure you are not locked out.

System / Account
Set Admin Password
Enter New Password for Admin

[Click to Re-enter and Confirm Password](#)

System / Account
Set Admin Password
Re-Enter New Password for Admin

Re-enter password to proceed.

System / Account
Set Admin Password
Re-Enter New Password for Admin

Password match. Confirm to proceed

[Ignore](#) [Confirm](#)

The password that you entered will be displayed. Pressing Ignore will send you back to enter a new admin password. Pressing Confirm takes you to the following menu. Once you hit Confirm, you will not be able to see or retrieve the password you entered.

Wi-Fi Connection Mode

Client

Access Point

If Client is selected the menus are:

Enable DHCP Client

ON

SSID

Password

Enable Modbus/TCP over Wi-Fi

OFF

Apply settings
Save or cancel changes

If Client is selected, and DHCP Client is OFF the menus are:

Enable DHCP Client



Dynamic Host Configuration Protocol is a network management protocol used to automate the process of configuring devices on IP networks. With it off, it allows the user to configure fixed parameters.

IP Address

Subnet Mask

Gateway

SSID

Password

Enable Modbus/TCP over Wi-Fi

 OFF

Apply settings

Save or cancel changes

Apply

Cancel

If Access Point is selected the menus are:

Enable DHCP Client

 OFF

IP Address

Subnet Mask

Gateway

SSID

Password

Encryption Mode

WPA PSK



WPA2 PSK



WPA + WPA2 PSK



The next 2 selections only appear if Enable DHCP Client is ON

Starting Address

Ending Address

Enable Modbus/TCP over Wi-Fi



Apply settings

Save or cancel changes

Apply

Cancel

Account Configuration

User Access

User Account

If Password is set to OFF, remote operation (Wi-Fi) will be disabled and configurations will be insecure.

System / Account

Enable Admin Password



Password Recommended to
make the configuration secure.

Caution: There is no default password to unlock your unit if you forget the password you have entered. Make sure to place a copy of your password in a secure location to ensure you are not locked out.

System / Account

Enable Admin Password



Security Enabled

Change Admin Password

Enter New Password for Admin

Change Admin Password

Enter New Password for Admin

Click to Re-enter and Confirm Password

System / Account

Change Admin Password

Re-Enter New Password for Admin

Re-enter password to proceed.

System / Account

Change Admin Password

Re-Enter New Password for Admin

Password match. Confirm to proceed

Ignore

Confirm

Modbus - read-only mode



This Modbus read only mode applies only to Modbus protocol and not RLC protocol. Setting this switch ON will let the user do Modbus reads only over the various interfaces (Wi-Fi, User RS485, RS232 and Ethernet modules). No writes are allowed if this read-only mode is turned ON.

Apply settings

Save or cancel changes

Apply

Cancel



Device

Signal Input Configuration

Control Input, Counter & Rate



Setup Input parameters

SP & Analog Configuration

Setpoint & Analog (Analog is only available with Analog module attached.)



Setup SP & Analog parameters

Function Configuration

Function Key & User Input



Setup Function



Device

Modbus Configuration

Modbus(ASCII/RTU/TCP) & RLC(ASCII)



Setup Wired Communication

Misc Configuration

Import/Export & Factory



Calibration, Firmware Update..

Signal Input Configuration

Device / Signal Input

Counter Input Configuration

Counter Configuration

Rate Configuration

Counter Input Configuration

This section sets the input configuration hardware type for counter and rate input signals.

Device / Control Input

Input

Input A (Count 1 input)



Input B (Count 2 input)



Digital Filter



Input logic Selection for Counter

High Acting



Low Acting



Logic Selection for Input

- Magnetic
- Source
- Sink

Factory setting is Sink (PM50 input terminal is high or at a voltage and the external sensor is taking it low.) See [Signal Inputs](#) in specifications for more details.

Apply settings

Save or cancel changes

Apply

Cancel

Counter Configuration

Device / Counter

Counter

- Counter A
- Counter B
- Counter C

Operating Mode Counter

Counter A (Input 1)

None	Does not count
Count x1	Adds Input A falling edge
Count x1 w/ Direction	Adds Input A falling edge if Input B is high. Subtracts Input A falling edge if Input B is low.
Dual Count x1 w/ Direction	Adds Input A falling edge if User 1 is high. Subtracts Input A falling edge if User 1 is low.
Dual Count x1 Add/Add	Adds Input A falling edge and Input B falling edge.
Dual Count x1 Add/Subtract	Adds Input A falling edge. Subtracts Input B falling edge.
Quadrature x1	Adds Input A rising edge when Input B is high. Subtracts Input A falling edge when Input B is high
Quadrature x2	Adds Input A rising edge when Input B is high and Input A falling edge when Input B is low. Subtracts Input A falling edge when Input B is high and Input A rising edge when Input B is low.
Quadrature x4	Adds Input A rising edge when Input B is high, Input A falling edge when Input B is low, Input B rising edge when Input A is low, and Input B falling edge when Input A is high. Subtracts Input A falling edge when Input B is high, Input A rising edge when Input B is low, Input B rising edge when Input A is high, and Input B falling edge when Input A is low.
Dual Count Quadrature x1	Adds Input A rising edge when User 1 is high. Subtracts Input A falling edge when User 1 is high.
Dual Count Quadrature x2	Adds Input A rising edge when User 1 is high and Input A falling edge when User 1 is low. Subtracts Input A falling edge when User 1 is high and Input A rising edge when User 1 is low.
Count x2	Adds Input A rising and falling edges.
Count x2 w/ Direction	Adds Input A rising and falling edges if Input B is high. Subtracts Input A rising and falling edge if Input B is low.
Dual Count x2 w/ Direction	Adds Input A rising and falling edges if User 1 is high. Subtracts Input A rising and falling edge if User 1 is low.

Note: When using Dual Count With Direction or Dual Count Quadrature Operating Modes User Input 1 must be programmed for none.

Counter B (Input 2)	
None	Does not count
Batch	Counter B internally counts the number of output activations of the selected setpoint(s). The count source is selected in the Yes/No sub-menu shown for each setpoint.
Count x1	Adds Input B falling edge.
Dual Count x1 w/ Direction	Adds Input B falling edge if User 2 is high. Subtracts Input B falling edge if User 2 is low.
Dual Count Quadrature x1	Adds Input B rising edge when User 2 is high. Subtracts Input B falling edge when User 2 is high.
Dual Count Quadrature x2	Adds Input B rising edge when User 2 is high and Input B falling edge when User 2 is low. Subtracts Input B falling edge when User 2 is high and Input B rising edge when User 2 is low.
Count x2	Adds Input B rising and falling edges.
Dual Count x2 w/ Direction	Adds Input B rising and falling edges if User 2 is high. Subtracts Input B rising and falling edge if User 2 is low.
Note: When using Dual Count Operating Modes User Input 2 must be programmed for none.	
Counter C	
None	Does not count
Counter A	Counter C counts the incoming pulses from Counter A Input as per Counter A mode of operation. The signal is scaled only according to Counter C parameters.
Counter B	Counter C counts the incoming pulses from Counter B Input as per Counter B mode of operation. The signal is scaled only according to Counter C parameters.
Counter A + Counter B ‡	Counter C counts the incoming pulses from Counter A and B inputs as per Counter A and B modes of operation. The result is scaled only according to Counter C parameters. (Example: If Counter A is set for Count X1 mode and Counter B is set for Count X2 mode, then Counter C will increment by 1 for each pulse received on Input A and increment by 2 for each pulse received on Input B. Counter C scale settings are then applied and the result displayed.)
‡ Note: Counter A, B and C must all be reset at the same time for the math to be shown correctly between the display values.	

Counter C (Cont'd)	
Counter A - Counter B ‡	Counter C counts the incoming pulses from Counter A and B inputs as per Counter A and B modes of operation and subtracts the B counts from the A counts. The result is scaled only according to Counter C parameters. (Example: If Counter A is set for Count X1 mode and Counter B is set for Count X2 mode, then Counter C will increment by 1 for each pulse received on Input A and decrement by 2 for each pulse received on Input B. Counter C scale settings are then applied and the result displayed.)
‡ Note: Counter A, B and C must all be reset at the same time for the math to be shown correctly between the display values.	
Batch	Counter C internally counts the number of output activations of the selected setpoint(s). The count source is selected in the Yes/No sub-menu shown for each setpoint.
Serial Slave	Counter C functions as a serial slave display.

Decimal Point	
0	<input type="radio"/>
0.0	<input type="radio"/>
0.00	<input type="radio"/>
0.000	<input type="radio"/>
0.0000	<input type="radio"/>
0.00000	<input type="radio"/>

This selects the decimal point position for the selected counter, and any setpoint value assigned to that counter. The selection will also affect that counter's scale factor calculations.

List Selection	
List A	<input type="radio"/>
List B	<input type="radio"/>

Scale Factor for List A

Scale Factor Range (0.00001 to 9.99999)

1.00000

The number of input counts for the selected counter is multiplied by the scale factor and the scale multiplier to obtain the desired process value. A scale factor of 1.00000 will result in the display of the actual number of input counts. For Counter A + Counter B and Counter A - Counter B modes of operation, the math is performed on the input signals and then the result is scaled by Counter C scaling. To achieve correct results, both Input A and Input B must provide the same amount of pulses per unit of measurement.

Count Load for List A

Range: -199999 to 999999

500

When Reset To Count Load action is chosen, the selected counter will reset to this value.

Scale Multiplier

0.01

0.1

1

10



The number of input counts for the selected counter is multiplied by the scale multiplier and the scale factor to obtain the desired process value.

Reset Action

Zero



Count Load



When the selected counter is reset, it returns to zero or the counter count load value. This reset action applies to all selected counter resets, except a setpoint generated counter auto reset programmed in [Setpoint Configuration -> Counter Auto Reset](#).

Reset At Power-Up

No



Yes



The selected counter may be programmed to reset at each unit power-up.

Apply settings

Save or cancel changes

Apply

Cancel

Rate Configuration

Rate Type	
Rate A	<input checked="" type="radio"/>
Rate B	<input checked="" type="radio"/>
Rate C	<input checked="" type="radio"/>
Common	<input checked="" type="radio"/>

Select the Rate parameters to be programmed. Rate A is Input 1 and Rate B is Input 2.

Enable Rate
<input checked="" type="checkbox"/>

Select ON to measure the rate (speed) of pulses on the corresponding Input. Rate measurement is independent of the corresponding Counter count modes. Default setting is OFF. When Enable Rate is set to ON, the following menus are shown.

Rate A and Rate B

Decimal Point	
0	<input checked="" type="radio"/>
0.0	<input type="radio"/>
0.00	<input type="radio"/>
0.000	<input type="radio"/>
0.0000	<input type="radio"/>

This selects the decimal point position for the selected Rate indicator.

Scaling Type

Enter Values



Apply Signal



Select whether the rate input values for scaling points will be entered by touchpad or by applying a signal. If Input Values and corresponding Display Values are known, the Enter Values scaling style can be used. This allows scaling without the presence of the input signal. If Input Values have to be derived from the actual input signal source or simulator, the Apply Signal scaling style must be used. If Apply Signal method is chosen, **Read Input** and **Save Input** buttons to read the Input and then save the value will follow each scaling point.

The previous entered value is displayed until Read Input is pressed and then the display shows the applied present value. Save Input saves that value. If you do not want to apply the value, then do not press Save but press the right advance arrow and it keeps the previous entered value.

Apply signal is only available through the PM50 touch screen. If the device is connected through Wi-Fi or any other communication, apply method is disabled.

Scaling Points

2

3

4

5

6

7

8

9

10

This parameter sets the number of scaling points for the Rate Scaling function. The number of scaling points used depends on the linearity of the process and the display accuracy required.

Linear processes use two scaling points to provide a linear Rate display from 0 up to the maximum input

frequency. For typical zero based frequency measurements, the lower point is set to display 0 for 0 Hz input (factory setting) and the upper point set to display the desired value for a given input frequency. For non-zero based applications, the lower point is set to the desired display for 0 Hz input.

For non-linear processes, up to 10 scaling points may be used to provide a piece-wise linear approximation representing the non-linear function. The Rate Display will be linear between sequential scaling points. Thus, the greater the number of scaling points, the greater the conformity accuracy.

Each scaling point is specified by two programmable parameters: A desired Rate Display Value (Display Point) and a corresponding Rate Input Value (Scaling Point). Scaling points are entered sequentially in ascending order of Rate Input value. Each scaling point defines the upper endpoint of a linear segment, with the lower endpoint being the previous scaling point.

Scaling Point 1

Range: 0.0 to 99999.9

Scaling Point is the Input signal frequency or Hz (pulses per second) value. For all zero-based applications, Scaling Point 1 must be 0, and the Display Point 1 must be 0. For non-zero based applications, enter or apply the corresponding Rate Input Value for Scaling Point 1.

Display Point 1

Range: 0 to 999999

Display Point is the Rate value to be displayed for the corresponding Scaling Point or Input signal value. For all zero-based applications (display value is 0 for 0 Hz), the Display Point 1 is 0. For non-zero based applications, enter the desired Display Point value for Scaling Point 1.

Scaling Point 2

Range: 0.0 to 999999.9

Enter or apply the corresponding Rate Input Value for Scaling Point 2. This value must be greater than Scaling Point 1.

Display Point 2

Range: 0 to 999999

Enter the desired Display Point value for Scaling Point 2.

Repeats for each successive pair.

Display Rounding

1

2

5

10

20

50

100

Rounding values other than '1' round the Rate display to the nearest increment selected (e.g. rounding of '5' causes 122 to round to 120 and 123 to round to 125). Rounding starts at the least significant digit of the Rate display.

Low Cut Out

Range: 0 to 999999

The Low Cut Out value forces the Rate display to zero when the Rate display falls below the value entered.

Apply settings

Save or cancel changes

Apply**Cancel**

Rate C

Rate C Parameters	
None	Rate C disabled.
Sum (A+B)	Rate C shows the sum of Rate A and Rate B.
Difference (A-B)	Rate C shows the difference of Rate A and Rate B.
Percent Ratio (A/B)	Rate C shows the percentage of Rate A to Rate B.
Percent of Total A/(A+B)	Rate C shows the percentage of Rate A to the total of Rate A and Rate B.
Percent Ratio (A-B)/B	Rate C shows the percent draw between Rate A and Rate B.

Decimal Point

0
0.0
0.00
0.000
0.0000



Rate C Multiplier

1
10
100
1000



Set the Rate C Multiplier to obtain the desired Rate C display resolution. For Rate C percentage calculations, the result is internally multiplied by 100 to show percent as a whole number. By using a Display Multiplier of 10, 100 or 1000, along with the proper decimal point position, percentage can be shown in tenths, hundredths or thousandths respectively.

Apply settings

Save or cancel changes

Apply

Cancel

Common

Rate Low Update Time

Range: 0.1 to 999.9 Sec

1.0

The Low Update Time is the minimum amount of time between display updates for all enabled Rate displays. Small Low Update Time values may increase the possibility of the display indicating an unstable input (jittery display).

Rate High Update Time

Range: 0.2 to 999.9 Sec

2.0

The High Update Time is the maximum amount of time before the enabled Rate displays are forced to zero. The High Update Time must be higher than the Low Update Time and higher than the desired slowest readable speed (one divided by pulses per second). The factory setting of 2.0, will force the display to zero for speeds below 0.5 Hz or a pulse every 2 seconds.

Maximum Capture Value Assignment

Rate A



Rate B



Rate C



Maximum Capture Delay Time

Range: 0.0 to 999.9 Sec

When the assigned Rate value is above the present Maximum rate value for the entered amount of time, the unit will capture that Rate value as the new Maximum value. A delay time helps to avoid false captures of sudden short spikes.

Minimum Capture Value Assignment

Rate A



Rate B



Rate C



Minimum Capture Delay Time

Range: 0.0 to 999.9 Sec

When the assigned Rate value is below the present Minimum rate value for the entered amount of time, the unit will capture that Rate value as the new Minimum value. A delay time helps to avoid false captures of sudden short spikes.

Apply settings

Save or cancel changes

Apply

Cancel

SP & Analog Configuration

Device / SP & Analog Configuration
Setpoint SSR Logic
Setpoint Configuration
Analog Configuration (If Analog Module is installed)

Setpoint SSR Logic

Device / SSR Logic
SSR Logic for Setpoint 1 and 2
Source
Sink

This setting only applies to Setpoints 1 and 2. Setting the SSR Logic for Source requires an external DC supply be connected per the wiring drawing shown in the [Installation Guide](#).

Apply settings

Save or cancel changes

Apply

Cancel

Setpoint Configuration

Device / Setpoint
Setpoint Number
<input type="button" value="Setpoint 1"/>
<input type="button" value="Setpoint 2"/>

If Dual Relay Module is installed you will see 4 setpoint selections and if the Quad Relay Module is installed you will see 6 setpoint selections.

Device / Setpoint (1)
Setpoint Assignment
None
Counter A
Counter B
Counter C
Rate A
Rate B
Rate C

Select the display to which the setpoint is assigned.

Setpoint Action	
No	<input type="radio"/>
Latched	<input type="radio"/>
Timed Out	<input type="radio"/>
Boundary	<input type="radio"/>

Select the desired Setpoint Output Action. Choose No (no action) if a setpoint is unused or for manual mode operation. See “Setpoint (Alarm) Figures for Rate” for a visual detail of Rate Assigned setpoint actions.

For Counter Assignments:

Latched	The setpoint output activates when the count value equals the setpoint value. The output remains active until reset.
Timed Out	The setpoint output activates when the count value equals the setpoint value and deactivates after the Time Out value.
Boundary	The setpoint output activates when the count value is greater than or equal to (for High Acting) or less than or equal to (for Low Acting) the setpoint value. The setpoint output will deactivate when the count value is less than (for High Acting) or greater than (for Low Acting) the setpoint value.

For Rate Assignments:

Latched	The setpoint output activates when the rate value is equal to the setpoint value. The setpoint output remains active until reset. If after reset, the rate value is greater than or equal to (for High Acting) or less than or equal to (for Low Acting) the setpoint value, the output will reactivate.
Timed Out	The setpoint output cycles when the rate value is greater than or equal to (for High Acting) or less than or equal to (for Low Acting) the setpoint value. The Setpoint Time Out and Setpoint On Delay values determine the cycling times.
Boundary	The setpoint output activates when the rate value is greater than or equal to (for High Acting) or less than or equal to (for Low Acting) the setpoint value. The setpoint output will deactivate (Auto reset) as determined by the Hysteresis value.

Output Logic

Normal



Reverse



Annunciator Type

Off



Normal



Flash



Reverse



Off - Disables display setpoint annunciators.

Normal - Displays the corresponding setpoint annunciators of "on" setpoint alarm outputs.

Flash - Flashes the corresponding setpoint annunciators of "on" setpoint alarm outputs.
This setting has precedence over normal.

Reverse - Displays the corresponding setpoint annunciators of "off" setpoint alarms outputs.

Setpoint Annunciator is the border around the display. If any setpoint is configured for a type other than Off and is in the corresponding listed active state, the border will be the Annunciator Color. Only if all setpoints configured for a type other than Off are **ALL** not in the corresponding listed active state, the border will be the color green. It is not possible to tell which individual setpoint is in the active state here.

Annunciator Color

Orange



Red



Annunciator Color sets the color of the display border when a setpoint is in the listed active state. Red shall have precedence over Orange.

Setpoint Active Color

Orange



Red



Setpoint Active Color is the color used in the Setpoint Status Widget and icons to show the active state of the configured setpoint individually. Clear is for not configured. Green is for not active. There are no flash or reverse selections. Red shall have precedence over Orange.

Configure List A/B

List A Config



List B Config



Two lists of setpoint point and band values are available. If a User Input or Function Key is configured and activated for Select Parameter List, then List B scaling will be used. The display will momentarily indicate which list is being used. If List B is being used, then all configured setpoints will be changed to List B values. If a specific setpoint is to remain the same value, then for that setpoint the value must be configured the same for both A and B. All other setpoint parameters will be the same for both lists.

Setpoint Value for List A

Range: -1999.99 to 9999.99

100

Enter desired setpoint alarm value. The decimal point position is determined by the Setpoint Assignment value.

Setpoint Tracking

Setpoint 1

Setpoint 2

Setpoint 3

Setpoint 4

Setpoint 5

Setpoint 6

CLd A

CLd B

CLd C

The value of the setpoint being programmed will track the entered selection's value. Tracking means that when the selection's value or Count Load value is changed, the setpoint value will also change (or follow) by the same amount. Setpoint 3-6 only show if a setpoint module is installed.

Note: Do not program a setpoint to track itself.

Output Power-Up State

Off



On



Save



Off will deactivate the output at power up. On will activate the output at power up. Save will restore the output to the same state it was at before the unit was powered down.

Counter Auto Reset

- None
- Zero at Start Activation
- Count Load at Start Activation

This automatically resets the display value of the Setpoint Assigned Counter each time the setpoint value is reached. The automatic reset can occur at output start or output end if the setpoint output action is programmed for timed output mode. The counter may be reset to zero or the count load value. This reset may be different from the counter reset action programmed in [Counter Configuration -> Reset Action](#).

Output Reset with Count Reset

- No
- Yes

Selecting Yes causes the Setpoint output to deactivate (reset) when the Setpoint Assigned Counter is reset. The only exception is when the assigned counter is reset by a setpoint generated counter auto reset.

Output Reset at Sn + 1

- No
- Sn-Str
- Sn-End

Selecting Sn-Str causes the setpoint output to deactivate (reset) when setpoint Sn + 1 activates. (Example: S1 deactivates when S2 activates, and S4 when S1 activates.) The last setpoint will wrap around to the first.

Selecting Sn-End causes the setpoint output to deactivate (reset) when setpoint Sn + 1 activates

and then times out (deactivates). This selection only applies if the $S_n + 1$ setpoint action is Timed Out. (Example: S1 deactivates when S2 is activated and then times out.) The last setpoint will wrap around to the first. This parameter is only available for Counter assigned setpoints.

Output Timed Out

Range: 0.0 to 599.99 Sec

1.00

If the setpoint action is Timed Out and the setpoint is assigned to Counter, then this is the amount of time the output will activate once the count value equals the setpoint value. If the setpoint action is Timed Out and the setpoint is assigned to Rate, then this is the amount of time the output is ON during the ON / OFF output cycling. If Rate Timed Output One-Shot mode is enabled, then this is the time duration for the one-shot output pulse.

Activation Boundary Type

High Acting

Low Acting

High Acting activates the output when the assigned display value equals or exceeds the setpoint value. Low Acting activates the output when the assigned display value is less than or equal to the setpoint.

Setpoint Standby Operation

No

Yes

This parameter only applies to low acting setpoint activation (boundary) type setpoints. Select Yes to disable a low acting setpoint at power-up, until the assigned display value crosses into the output "off"

area. Once in the output “off” area, the setpoint will function per the description for low acting activation (boundary) type.

The next menus are for Rate Outputs only

Hysteresis

Range: 0 to 59999

2

The hysteresis value is added to (for low acting), or subtracted from (for high acting), the setpoint value to determine at what value to deactivate the associated setpoint output. Hysteresis is only available for Rate assigned setpoints.

On Time Delay

Range: 0.0 to 599.99 Sec

0.00

This is the amount of time the assigned Rate display must meet the setpoint activation requirements (below setpoint for Low Acting and above setpoint for High Acting), before the setpoint output activates. If the Rate Setpoint Action is Timed-Out, this is the amount of time the output is OFF during the ON/OFF output cycling. This parameter is only available for Rate assigned setpoints.

Off Time Delay

Range: 0.0 to 599.99 Sec

0.00

This is the amount of time the assigned Rate display must meet the setpoint deactivation requirements (below hysteresis for High Acting and above hysteresis for Low Acting), before the setpoint output deactivates. This parameter is only available for Rate assigned setpoints.

Rate Timed Output One-Shot

No



Yes



If the setpoint action is Timed Out and the setpoint is assigned to Rate, select Yes to have the output activate for a single pulse (one-shot) when the assigned Rate display meets the setpoint activation requirements. Select No for ON / OFF output cycling per the “Setpoint (Alarm) Figures For Rate” diagram.

Apply settings

Save or cancel changes

Apply

Cancel

Repeat the above section for each setpoint to be used. Each setpoint corresponds to the output with the same identifier number.

Setpoint (Alarm) Figures for Rate

(For Reverse Logic, The Alarm state is opposite.)

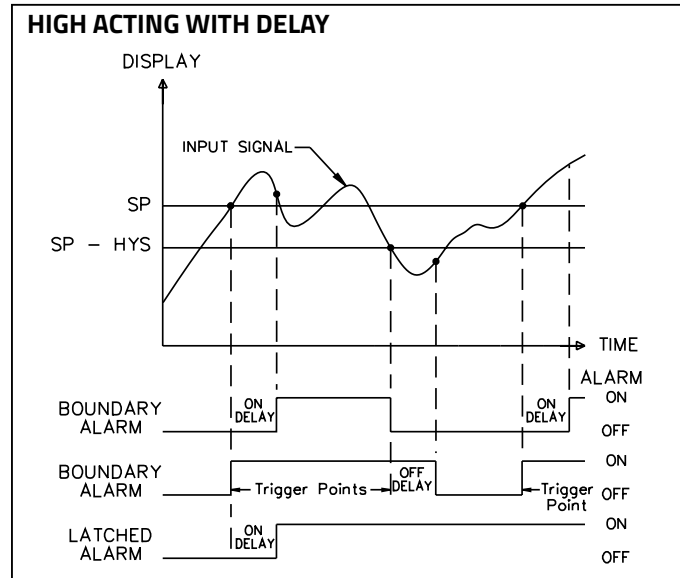
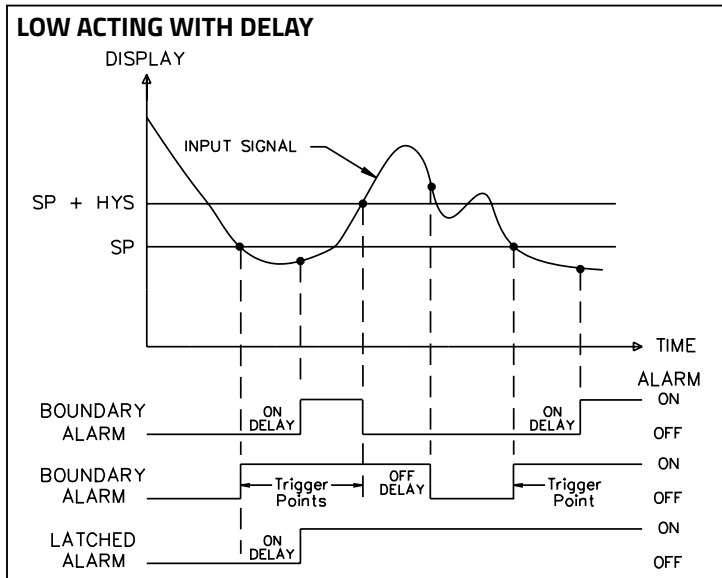
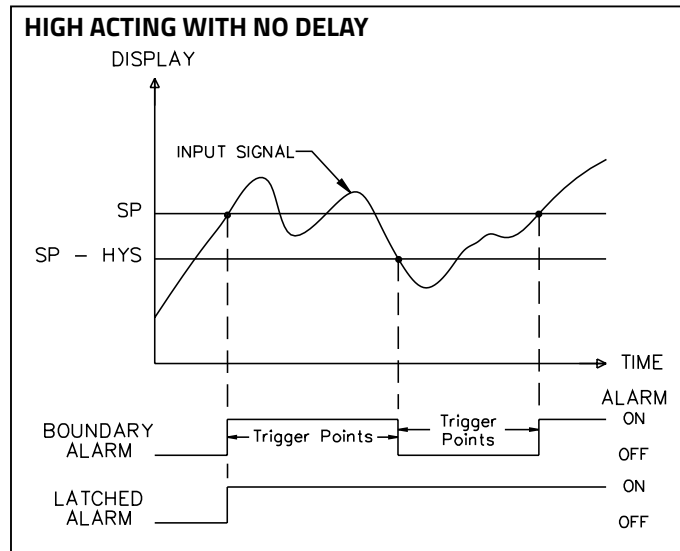
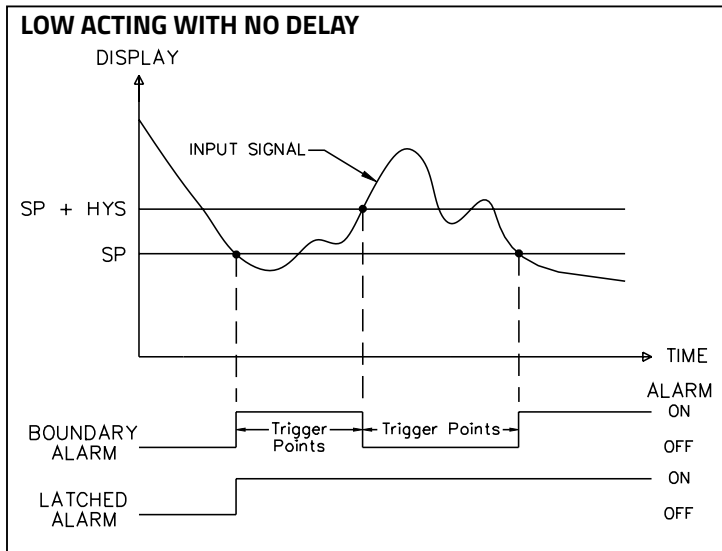

LOW ACTING WITH TIMEOUT

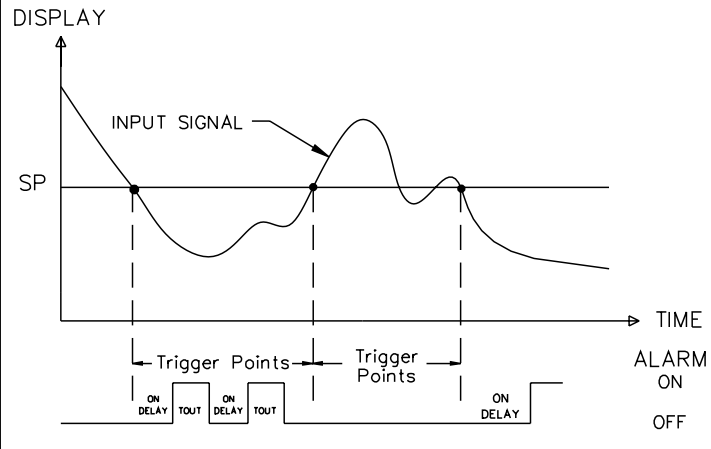

HIGH ACTING WITH TIMEOUT

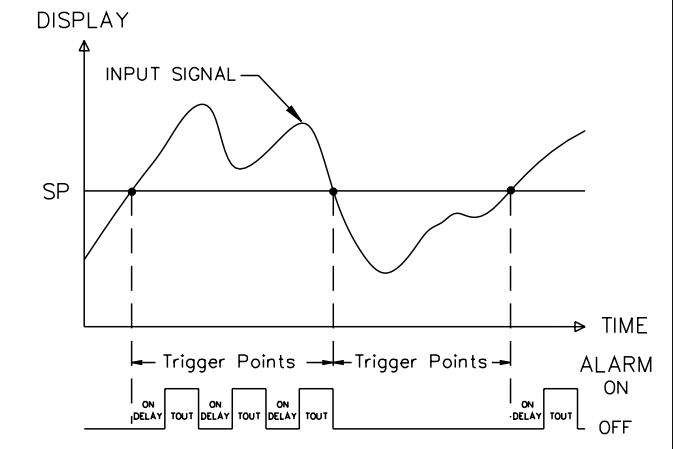

Analog Configuration

This menu is only available with the Analog Output Module installed.

Device / Analog	
Analog Output Type	
4 to 20 mA	<input checked="" type="radio"/>
0 to 20 mA	<input type="radio"/>
0 to 10 VDC	<input type="radio"/>
-10 to +10 VDC	<input type="radio"/>

Analog Output Assignment	
None	<input checked="" type="radio"/>
Counter A	<input type="radio"/>
Counter A	<input type="radio"/>
Counter A	<input type="radio"/>
Rate A	<input type="radio"/>
Rate B	<input type="radio"/>
Rate C	<input type="radio"/>
Max	<input type="radio"/>
Min	<input type="radio"/>

Select the source that the analog output will retransmit.

Analog Low Scale

Range: -199999 to 999999

Enter the Analog Output Assignment display value that corresponds to the lowest output signal of the selected Analog Output Type.

Analog High Scale

Range: -199999 to 999999

Enter the Analog Output Assignment display value that will corresponds to the highest output signal of the selected Analog Output Type.

Apply settings

Save or cancel changes

Apply

Cancel

Function Configuration

Device / Function

Function Key Configuration

User Input Configuration

Function Key Configuration

Enable Function Key



The function keys can perform their function through Wi-Fi. To show or hide the function keys, press the bottom left arrow while in the Display mode.

Function Key

F1



F2



F3



F4



There are only two Function keys on the 3.5 inch PM-50.

Rename Key

Rename Key lets you create your own 5 character label for the Function Key you are configuring.

Select Function

A function key can be assigned to perform more than one function at the same time. Momentary actions take place after the release of the key.

None	No function is performed if activated. This is the factory setting for all function keys.
Print and Reset	This Function Key issues a single block print through the serial port when activated, and the serial type is set to RLC Protocol. In addition, when activated (momentary action), the unit performs a reset of the displays selected. This is independent of the display being shown and, unless selected, will not affect Counter C value.
Maintained Reset and Inhibit	The unit performs a reset and inhibits the displays selected, as long as activated (maintained action). This is independent of the display being shown and, unless selected, will not affect Counter C value.
Momentary Reset	When activated (momentary action), the unit resets the displays selected. This is independent of the display being shown and, unless selected, will not affect Counter C value.
Store and Reset Display	The unit holds (freezes) the displays and then performs a reset of the displays selected, as long as activated (maintained action). This is independent of the display being shown and, unless selected, will not affect Counter C value.
Maintained Output Reset	The unit deactivates (resets) the setpoint outputs selected, as long as activated (maintained action). This can also prevent a setpoint output from activating.
Momentary Output Reset	When activated (momentary action), the unit resets the setpoint outputs selected.
Display Brightness	When activated (momentary action), the display brightness changes to the next level.
Select Parameter List	Two lists of input scaling points and setpoint values (including band and deviation) are available. The display will momentarily indicate which list is active when the List B scaling is changed. Scaling List B must be enabled for this function to be performed. Scaling points can be disabled from changing to List B. However, this will always enable all configured setpoints to their List B values. If you do not want a value to change then you must make that setpoint List A and List B value the same. Scaling of rate display is not affected by the list parameter.

Print	This Function Key issues a single block print through the serial port when activated, and the serial type is set to RLC Protocol. The data transmitted during a print request and the serial type is programmed in Modbus Configuration → RS485 Configuration → Communication Type → RLC Protocol .
Inhibit	The unit inhibits the displays selected, as long as activated (maintained action).
Store	The unit holds (freezes) the displays selected, as long as activated (maintained action). Internally, the counters and max and min values continue to update. Inhibiting Counter A or Counter B may affect Counter C. When released, the displays will update to their background accumulated value.
Maintained Output Active	The unit activates (sets) the setpoint outputs selected, as long as activated (maintained action).
Momentary Output Active	When activated (momentary action), the unit activates (sets) the setpoint outputs selected.
Setpoint Hold	The unit holds the state of the setpoint outputs selected, as long as activated (maintained action).

Reset Selections

Counter A
Counter B
Counter C
Min Display
Max Display

Apply settings

Save or cancel changes

Apply

Cancel

Repeat the above section for each function key to be configured.

User Input Configuration

Device / User Input
SNK/SRC
User Input

Functions / SSR
Active Status

Sink	<input checked="" type="radio"/>
Source	<input checked="" type="radio"/>

Sink refers to active state when user voltage is low.
Source refers to active state when user voltage is high.

Apply settings
Save or cancel changes

Apply **Cancel**

User Input / Functions

Hardware Input

User Input 1



User Input 2



Note: User Inputs must be configured as none when Counters are programmed for Dual Quad or Dual Count with Direction.

Function

The user input can be assigned to perform more than one function at the same time.

None	No function is performed if activated. This is the factory setting for all user inputs.
Program Lockout	Configuration Mode is locked-out, as long as activated (maintained action). The password will not override this.
Print and Reset	The unit issues a single block print through the serial port when activated, and the serial type is set to RLC Protocol. In addition, when activated (momentary action), the unit performs a reset of the displays selected. This is independent of the display being shown and, unless selected, will not affect Counter C value.
Maintained Reset and Inhibit	The unit performs a reset and inhibits the displays selected, as long as activated (maintained action). This is independent of the display being shown and, unless selected, will not affect Counter C value.
Momentary Reset	When activated (momentary action), the unit resets the displays selected. This is independent of the display being shown and, unless selected, will not affect Counter C value.
Store and Reset Display	The unit holds (freezes) the displays and then performs a reset of the displays selected, as long as activated (maintained action). This is independent of the display being shown and, unless selected, will not affect Counter C value.
Maintained Output Reset	The unit deactivates (resets) the setpoint outputs selected, as long as activated (maintained action). This can also prevent a setpoint output from activating.

Momentary Output Reset	When activated (momentary action), the unit resets the setpoint outputs selected.
Display Brightness	When activated (momentary action), the display brightness changes to the next level.
Select Parameter List	Two lists of input scaling points and setpoint values (including band and deviation) are available. The display will momentarily indicate which list is active when the List B scaling is changed. Scaling List B must be enabled for this function to be performed. Scaling points can be disabled from changing to List B. However, this will always enable all configured setpoints to their List B values. If you do not want a value to change then you must make that counter scale factor, count load value and setpoint List A and List B value the same.
Print	The unit issues a block print through the serial port when activated, and the serial type is set to RLC Protocol. The data transmitted during a print request and the serial type is programmed in Modbus Configuration → RS485 Configuration → Communication Type → RLC Protocol . If the user input is still active after the transmission is complete (about 100 msec), an additional transmission occurs.
Inhibit	The unit inhibits the displays selected, as long as activated (maintained action).
Store	The unit holds (freezes) the displays selected, as long as activated (maintained action). Internally, the counters and max and min values continue to update. Inhibiting Counter A or Counter B may affect Counter C. When released, the displays will update to their background accumulated value.
Maintained Output Active	The unit activates (sets) the setpoint outputs selected, as long as activated (maintained action).
Momentary Output Active	When activated (momentary action), the unit activates (sets) the setpoint outputs selected.
Setpoint Hold	The unit holds the state of the setpoint outputs selected, as long as activated (maintained action).

Apply settings

Save or cancel changes

Apply

Cancel

Repeat the above section for each user input to be configured.

Modbus Configuration

Device / Communication

RS485 Configuration

RS232 Configuration (With Module installed)

Ethernet Configuration (With Module installed)

RS485 or RS232 Configuration

The menus for RS485 and RS232 Configuration are the same.

Communication Type

Modbus ASCII

Modbus RTU

RLC Protocol (ASCII)

None

Baud Rate

1200

2400

4800

9600

19200

38400

57600

115200

Data Bit

7



8



Parity Bit

None



Even



Odd



Stop Bits

1



2



Modbus Station Number

Range: 1 to 247

247

If RLC Protocol is selected, the following menus appear instead of Modbus Station:

RLC Station Number
Range: 0 to 99

If the station number is 00, it will not be sent during a full transmission.

Enable Abbreviated Transmission

ON OFF

Select OFF for full print or Command T transmissions (station number, mnemonics and parameter data) or ON for abbreviated print transmissions (parameter data only). This will affect all the parameters selected in the print options.

Transmit Delay
Range: 0 to 250 ms

Following a transmit value (“*” or (\$) terminator) or Modbus command, the PM-50 will wait this minimum amount of time in seconds before issuing a serial response.

Print Options

Counter A

Counter B

Counter C

Rate A

Rate B

Rate C

Maximum

Minimum

Scale Factor

Counter Load Values

Setpoint Values

Apply settings

Save or cancel changes

Apply

Cancel

Ethernet Configuration

Enable DHCP Client



IP Address

Subnet Mask

Apply settings

Save or cancel changes

Apply

Cancel

Misc. Configuration

Device / Misc.

Import / Export Configuration

Factory Configuration

Firmware Upload

Device & Module Calibration

About this Device

Reboot the Device

Misc. / Import/Export

Import Config from SD

Export Config to SD

Import ScalePoint from SD

Export ScalePoint to SD

Selecting either import option will bring up the following warning:

This will Reboot the device

Continue

Exit

Pressing continue brings up the Import screen, while Exit will return you to the main Misc. Configuration menu.

Import Config from SD Card

Filename

Import

Status:

The file name must be config.txt for a successful import. You can change the file name after exporting, however, before you import the file into a PM-50 you must change the name back to config.txt.

When using the microSD Card and you click the import button, one of the following status messages will appear based on the microSD card:

No microSD Card detected - when the microSD card is not available in the slot, or the microSD card is an incompatible size or format

File not found - If the microSD card is present, but the config.txt file does not exist

Import successful, Rebooting - When the config.txt file is imported successfully, the device reboots to activate the configuration

Export Config to SD Card

Filename

Export

Status:

Exporting a new file to the microSD Card will overwrite the existing config.txt file on the card. You can change the file name after exporting to store more than one configuration program on a separate electronic device. The config.txt file can be viewed and edited using a text editor. However, caution must be taken because one wrong space, entry, or deletion can cause the file to be not readable by the PM-50.

Use this with caution.

Import ScalePoint from SD Card

Filename

Import

Status:

Export ScalePoint to SD Card

Filename

Export

Status:

After completing the import / export operation, press the left arrow twice to return to the main Misc Configuration Menu.

Factory Configuration

Misc. / Factory

Enable Screen Calibration



This is the Factory Default setting.

Enable Screen Calibration



Device Requires Reboot

This setting will allow calibration of the Touch screen upon reboot of the device. If calibration of the screen is done incorrectly, a reboot will allow the calibration to be done again. Remember to turn off after successful calibration.

Perform Factory Default



This is the Factory Default setting.

Perform Factory Default



Setting this switch to ON brings up the following warning screen. Pressing the **Proceed** button immediately resets and restarts the device. All user settings are returned to Factory Default, including the Admin password. This will also restart the Programming Wizard.



Warning

This will reset all device configuration to Factory Default values.

DEVICE WOULD RESTART AFTER RESET

Cancel

Proceed

Enable Programming Wizard



This will automatically go back to off after reboot. The Wizard will have the previous programmed configurations.

Enable Programming Wizard



Device Requires Reboot

This will automatically go back to off after reboot. The Wizard will have the previous programmed configurations.

Apply settings

Save or cancel changes

Apply

Cancel

Firmware Upload

Misc. / Firmware Upload

Firmware details

SD Card Firmware
Firmware Name
Firmware Version

Active Firmware
Firmware Name
Firmware Version

Firmware details are displayed with an Upload button. It will show the SD card firmware version and the firmware version presently in the PM50. The gpmcore.fwb file will auto detect the PM50 model. It is strongly suggested that the configuration in the PM50 (config.txt file) be saved to a separate SD card before updating to a new firmware version.

SD Card Firmware Upload

(Device will be rebooted)
Firmware Name
Firmware Version

Press the Upload button at the bottom of the screen to perform the upload of firmware from the SD card.

Firmware Upload Status

Firmware Name
Firmware Version
Verifying Package Complete
Fetching Binary
Please wait ...

During the upload of the firmware, a screen appears showing the status of the upload. Once the upload is complete the unit resets to the main menu. User settings from the previous firmware are retained.

Note: Do not disconnect power during the upload process. Loss of power could result in unit failure.

Device & Module Calibration

Device / Calibration
Device Calibration
AO Module Calibration

Device Calibration

The unit has been fully calibrated at the factory. Scaling to convert the input signal to a desired display value is performed in Signal Input Configuration. If the unit appears to be indicating incorrectly or inaccurately, refer to Troubleshooting before attempting to calibrate the unit. When recalibration is required (generally every 2 years), it should only be performed by qualified technicians using appropriate equipment. Calibration does not change any user programmed parameters. However, it will affect the accuracy of the input signal and the values previously stored using the Apply Scaling Style.

Enter Access Code

Access Code for calibration is 48.

Calibration Rate A: 0 Hz

Enter Offset (-0.0100% to 0.0100%)

Apply settings

Save or cancel changes

Apply

Cancel

AO Module Calibration

Enter Access Code

Access Code for calibration is 48.

Input Range

4 to 20 mA

0 to 20 mA

0 to 10 VDC

-10 to +10 VDC

Select the Input Range for the Analog Output that you want to calibrate.

Zero-offset ‡

Enter Value shown on Meter

‡ The Range being calibrated will be shown here.

Gain ‡

Enter Value shown on Meter

‡ The Range being calibrated will be shown here.

Save Calibration Values

SAVE

CANCEL

If you choose to CANCEL Calibration, the following menu appears.

Continue Calibration ?

CONTINUE

EXIT

About this Device

Misc. / **About**

About this Device

General Information

Size:

Type:

Firmware Version:

Secure Boot:

Serial Number:

Part Number:

All of the General Information about this device will be displayed on this screen. Pressing the next arrow will advance through the screens showing the information about Network and module information (MAC ID, IP address etc). This is followed by a screen listing the Part Numbers of all installed modules. To exit this menu, press Misc. / **About** menu header or one of the Configuration icons.

The following screen is an example of the Network information that will be displayed.

About this Device

Network Information

Wi-Fi MAC:

IP Info:

Wi-Fi Status:

The following screen is an example of the Ethernet module information that will be displayed. The information displayed will be module dependent.

About this Device

Ethernet Module Information

Part Number:

IP Info (Static):

Subnet Mask:

Ethernet Module MAC::

Ethernet Status:

The following is an example of what will be displayed depending on the modules you have installed.

About this Device

Modules Part Number:

Analog Out: PMM000IOAN000000

RS232: PMM000CM23200000

Ethernet: PMM000CMEN000000

Quad Relay: PMM000IORL400000:

Reboot the Device

Misc. / Reboot

This will Reboot the device

Continue

Exit

Pressing continue immediately reboots (power cycles) the unit and returns you to the main display, while Exit will return you to the main Misc. Configuration menu.



Home Screen

Screen Configuration

Screen Set-up



Update screen

This section allows the user to configure the 4 screens to display the device status and statistics based on the display size. These additional page views can be accessed from the Main Display by swiping either left or right.

1. For 3.5" display size, one screen/widget per page view.
2. For 4.3" display size, two screens/ widgets per page view. The 4.3 will also support combining two screens to create a large numeric widget for displaying status and statistics.

System / Home Screen

Large Numeric Widget

Widget Selection

Screen / Large Numeric

Enable Large Numeric Mode (Only for 4.3" models)

Merge Home screen 3 & 4 together as Numeric Widget



Your choices are either ON to merge screens 3 & 4, or OFF which disables the large numeric.

Apply settings

Save or cancel changes

Apply

Cancel

Widget Selection

Screen	
Screen Number	
1	<input checked="" type="radio"/>
2	<input checked="" type="radio"/>
3	<input checked="" type="radio"/>
4	<input checked="" type="radio"/>

If Large Numeric Mode was enabled, 3 and 4 are replaced with Large Numeric selection.

Screen (1)	
Display Style	
None	<input checked="" type="radio"/>
Gauge	<input checked="" type="radio"/>
Setpoint Status	<input checked="" type="radio"/>
Numeric	<input checked="" type="radio"/>
Max Min Total Monitor	<input checked="" type="radio"/>

Signal Type

Counter



Rate



The Input value shown will be based on the active scaling List A or B and the active Absolute or Relative selection.

Counter Type

Select Multiple to Scroll

Counter A



Counter B



Counter C



Rate Type

Select Multiple to Scroll

Rate A



Rate B



Rate C



Hi



Lo



Unit for Counter/Rate A

units

Display Units is a 10 digit title that can be used to describe the numbers being shown. This title will remain the same when switching between lists and Absolute and Relative.

Scroll Update Time

Range: 3 to 15 Seconds

The Maximum and Minimum Display Values are only applicable for Gauge. The valid range for Gauge widget inputs is -199999 to 999999. The min values must be lower than the max values. These values are for graphical display units and are not the calculated Rate minimum and maximum values.

Minimum Display Value

Maximum Display Value

Color Band 1

Red



Blue



Green



Yellow



Percentage Band 1

20

Color Band 2

Red



Blue



Green



Yellow



Percentage Band 2

60

Color Band 3

Red



Blue



Green



Yellow



Percentage Band 3

100

Setpoint Status

Setpoint Status will display the independent status of the setpoint using a colored circle. It will not show the value for the setpoint. Setpoint 1 and 2 are always shown as part of the main icons.

Max Min Total Monitor

The Max and Min displays will always show with this selection even though they may not be activated. To keep one or more of the displays from showing a value, you must activate a User Input or Function Key for maintain reset of that display.

Apply settings

Save or cancel changes

Apply

Cancel

Hardware Setup

For the most up to date specifications refer to the Installation Guide for your specific model. Found [here](#). Specification information for specific modules can be found at the same location.

Specifications

Note: The PM-50 4.3 inch host accepts a maximum of 5 modules while the 3.5 inch host accepts a maximum of 3 modules. Only one module from each function type (i.e. communication, relay, analog output) can be installed.

POWER: The meter is intended to be powered by NEC/CEC class 2, IEC/EN/UL 60950-1 LPS or UL/CSA 601010-1 Limited Energy power source.

MODEL	4.3-INCH	3.5-INCH
Input Voltage (Volts)	10-30 VDC	10-30 VDC
Max Power PM-50 only	4.6 W	4.6 W
Max Power PM-50, with modules	12 W	12 W

Host Isolation: 500 Vrms for 1 min. to all inputs and outputs.

DISPLAY: 4.3" or 3.5" Color TFT display with resistive analog touch screen

SIZE	4.3-INCH	3.5-INCH
TYPE	TFT	TFT
COLORS	262,144 K	262,144 K
PIXELS	480 X 272	320 X 240
BRIGHTNESS	420 cd/m ²	540 cd/m ²
LED BACKLIGHT LIFE*	30,000 HR TYP.	30,000 HR TYP.

* Lifetime at room temperature (25°C)

SENSOR POWER:

+24 VDC, ±5% @ 50 mA max.

COUNTER DISPLAYS:

 9 digits available

Display Range: -99,999,999 to 999,999,999

Over Range Display: Overage

Under Range Display: Underrange

Display Designators: Cnt-A, Cnt-B, Cnt-C

Maximum Count Rates: 50% duty cycle

If Setpoints Disabled: 35 KHz for all modes except Quadrature x4 (32 KHz)

If Setpoint(S) Enabled: 20 KHz for any mode except Quadrature x1 (19 KHz), Quadrature x2 (17 KHz) and Quadrature x4 (10 KHz)

RATE DISPLAYS: 6-digit

Maximum Frequency: 50 KHz
Minimum Frequency: 0.001 Hz
Display Update Time: 0.1 to 999.9 seconds
Accuracy: $\pm 0.01\%$

SIGNAL INPUTS (INPUT A and INPUT B):

Software configurable input types including switch contacts, TTL outputs, magnetic pickups and all standard RLC sensors. Inputs are configurable for current sinking or current sourcing outputs with input filtering for low frequency signals or switch contact debounce. Not isolated from the sensor input common.

Logic: Input trigger levels $V_{IL} = 1.2 \text{ V max.}; V_{IH} = 3.75 \text{ V min.}$

Sink: Adds internal 7.8 K Ω pull-up resistor to +5 VDC, 0.7 mA max

Source: Adds internal 3.9 K Ω pull-down resistor, 7.3 mA max. at 28 VDC, $V_{MAX} = 30 \text{ VDC}$

Magnetic Pickup:

$V_{IN_PK} = 200 \text{ mV}; V_{IN_HSYS} = 100 \text{ mV};$ Must also have SRC selection turned on through software

$V_{MAX} = \pm 40 \text{ V}_{PEAK}$ or 28 Vrms

Dual Count Modes:

When any dual count mode is used, then User Inputs 1 and/or 2 will accept the second signal of each signal pair. The user inputs do not have the Logic/Mag, HI/LO Freq, and Sink/Source software selections.

The user inputs are inherently a logic input with no low frequency filtering implemented in software.

The user input may only be selected for sink/source by the User Input Active parameter.

USER INPUTS: Two programmable user inputs

Max. Continuous Input: 30 VDC

Isolation to Sensor Input Common: Not isolated.

Logic State: User programmable for sink/source (Lo/Hi)

INPUT STATE	LO/SINK	HI/SOURCE
	20 K Ω pull-up to +3.3 V	20 K Ω pull-down
Active	$V_{IN} < 0.9 \text{ VDC}$	$V_{IN} > 2.4 \text{ VDC}$
Inactive	$V_{IN} > 2.4 \text{ VDC}$	$V_{IN} < 0.9 \text{ VDC}$

MEMORY: Nonvolatile memory retains all programmable parameters and display values.

Memory Card: microSD slot accepts up to 32 GB capacity cards in FAT16/FAT32 format.

RS485 SERIAL PORT: Uses Modbus protocol

Baud Rate: Up to 115,200

Data Format: 7/8 bit; odd, even, or no parity; 1 or 2 stop bits

Isolation: 500 Vrms to sensor, user power and digital inputs. Not isolated to solid state outputs

Wi-Fi CAPABILITIES:

Wi-Fi: Power output up to 20.5 dBm

Frequency:

TECHNOLOGY	CHANNELS	FREQUENCIES
Wi-Fi	1-13	2412-2484 MHz

Note: Channel/frequency limitation is enforced based on configured country/region code.

Wi-Fi Compliance: TCP/IP; 802.11 b/g/n

ON-BOARD DUAL SSR OUTPUTS: Both outputs must be used either in SINKING or in SOURCING mode together.

Sinking Mode:

Type: Switched DC, N-channel open drain MOSFET

Max Sink Current: 100 mA

V_{DS} ON: 0.3 V @ 100 mA

V_{DS} MAX: 30 VDC

Offstate Leakage Current: 0.5 mA max

Sourcing Mode:

Type: Switched DC, P-channel open source MOSFET

Max Source Current: 100 mA

V_{DS} ON: 0.3 V @ 100 mA

V_{DS} MAX: 30 VDC

Offstate Leakage Current: 0.5 mA max

ENVIRONMENTAL CONDITIONS:

Operating Temperature Range: -10 to 55 °C

Storage Temperature Range: -20 to 60 °C

Operating and Storage Humidity: 0 to 85% max. RH non-condensing

Vibration to IEC 68-2-6: Operational 5-500 Hz, 2 g

Shock to IEC 68-2-27: Operational 20 g (10 g relay)

Altitude: Up to 2000 meters

Installation Category II, Pollution Degree 2 as defined in IEC/EN 60664-1.

CERTIFICATIONS AND COMPLIANCES:

CE Approved

EN 61326-1 Immunity to Industrial Locations

Emission CISPR 11 Class A

IEC/EN 61010-1

RoHS Compliant

FCC ID #: 2AC7Z-ESP32WROOM32U

UL Hazardous: File # E317425

Type 4X Indoor/IP65 Enclosure rating (Face only) for all models

IP20 Enclosure rating (Rear of unit)

CONNECTIONS: High compression spring-clamp terminal block

Wire Strip Length: 0.32-0.35" (8-9 mm)

Wire Gauge Capacity: Four 28 AWG (0.32 mm) solid,
two 20 AWG (0.61 mm) or one 16 AWG (2.55 mm)

CONSTRUCTION: This unit is rated NEMA 4X/IP65 for indoor use only. IP20 Touch safe. One piece bezel/case. Flame resistant. Panel gasket, module locks, and mounting panel latch included.

MOUNTING REQUIREMENTS: Maximum panel thickness is 0.25" (6.35 mm). For NEMA 4X/IP65 sealing, a steel panel with a minimum thickness of 0.04" (1.02 mm) is recommended.

Panel Latch Screw Torque: 5.0 lbf-in (0.56 Nm) **CAUTION: DO NOT OVERTIGHTEN**

WEIGHT:

4.3: 11.3 oz (321 g)

3.5: 7.9 oz (224 g)

DIMENSIONS In inches (mm)

4.3 Inch Display

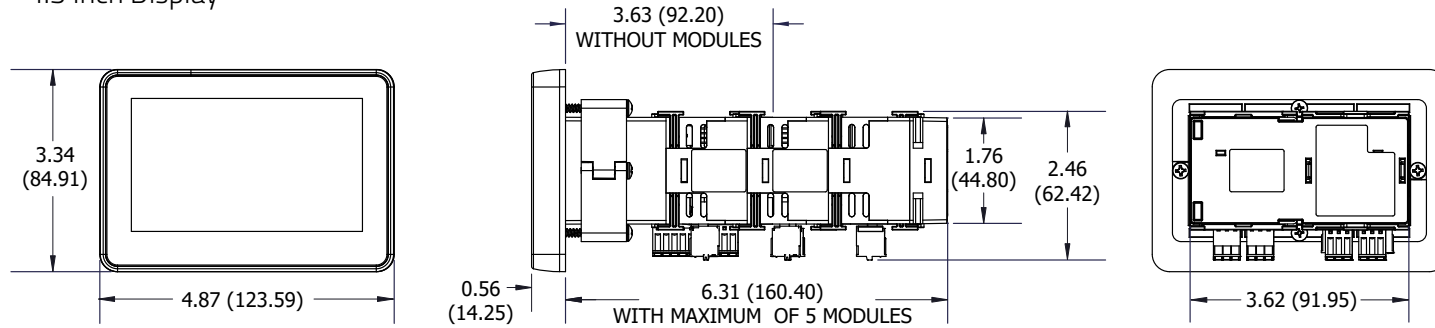

3.5 Inch Display

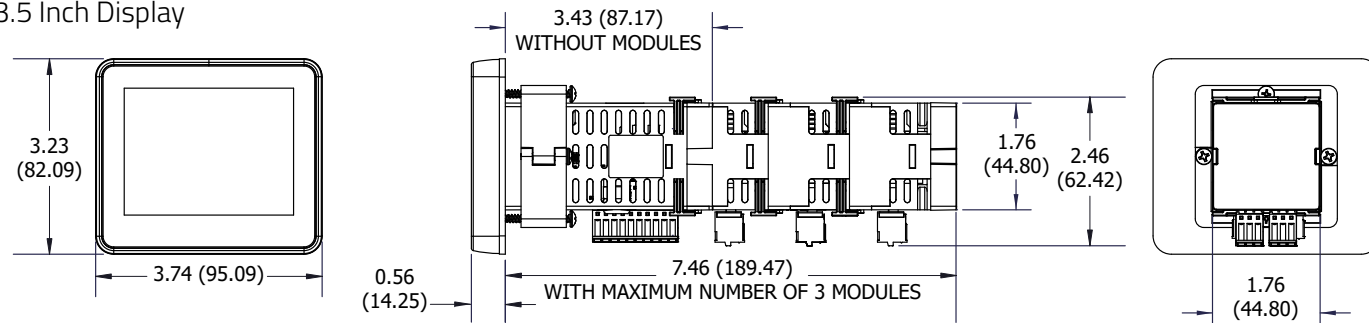

INSTALLATION ENVIRONMENT

The unit should be installed in a location that does not exceed its own operating temperature and provides good air circulation. Placing the unit near devices that generate excessive heat should be avoided.

The PM-50 4.3 and 3.5 inch models meet NEMA 4X/IP65 requirements when properly installed. This unit is designed for through-panel mounting. The mounting surface should have a minimum thickness of 0.04" (1.02 mm) and maximum thickness of 0.25" (6.35 mm). Cut the mounting hole per the dimensions shown in the diagram. Care should be taken to remove any loose material from the mounting cut-out to prevent that material from falling into the unit during installation. Prepare the panel cutout to the dimensions shown.

4.3 Inch Meter (1/8 DIN Cut Out)

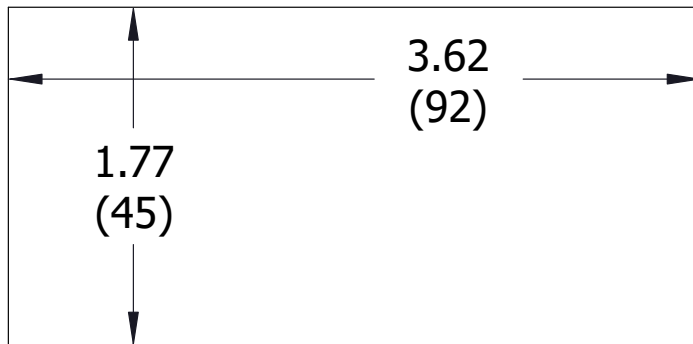

3.5 Inch Meter (1/16 DIN Cut Out)

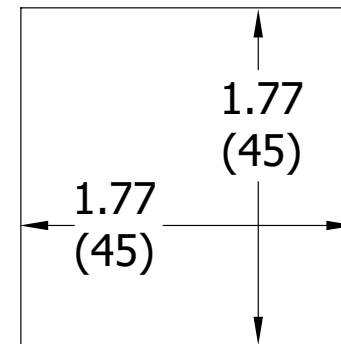

For hazardous location installation the following shall be taken into consideration:

- The device shall be panel mounted in a tool accessible enclosure with a minimum ingress protection rating of at least IP64 as defined in IEC/EN 60529.
- This device is open-type and must be mounted in a suitable dust-tight end-enclosure in accordance with articles 500 and 502 of the NEC and positioned so only the face of the display is exposed.
- Must be wired using Division 2 wiring methods as specified in article 501-4(b), 502-4(b), and 503-3(b) of the National Electric Code, NFPA 70 for installation within the United States, or as specified in section 19-152 of Canadian Electrical Code for installation in Canada.

Ordering Information

DESCRIPTION	PART NUMBER
4.3" Digital Input Graphical Panel Meter	PM500D0400800F00
3.5" Digital Input Graphical Panel Meter	PM500D0301600F00

Accessories

TYPE	DESCRIPTION	PART NUMBER
Modules	RS232 Serial Communications Module	PMM000CM23200000
	Ethernet Communications Module	PMM000CMEN00000
	Analog Output Module	PMM000IOAN000000
	Dual Setpoint Relay Output Module	PMM000IORL200000
	Quad Setpoint Relay Output Module	PMM000IORL400000
	AC to DC Power Module	PMM000PWACP00000
Misc.	Replacement Rear Cover/Bus Board with Spacer Module (4.3" model only)	PMA000CP00800000
	Conversion Panel 92 mm x 75 mm to 1/8 DIN	PMA000MK00800000
	Conversion Panel 68 mm x 68 mm to 1/16 DIN	PMA000MK01600000
	Replacement Module Lock Pins	PMA000MKLP00000
	4.3" Protective Screen Overlay	PMA000SP00800000
	3.5" Protective Screen Overlay	PMA000SP01600000
	MicroSD Card	SD032G00

METER INSTALLATION

Slide the panel gasket over the rear of the unit to the back of the bezel. The unit should be installed fully assembled. Insert the unit into the panel cutout.

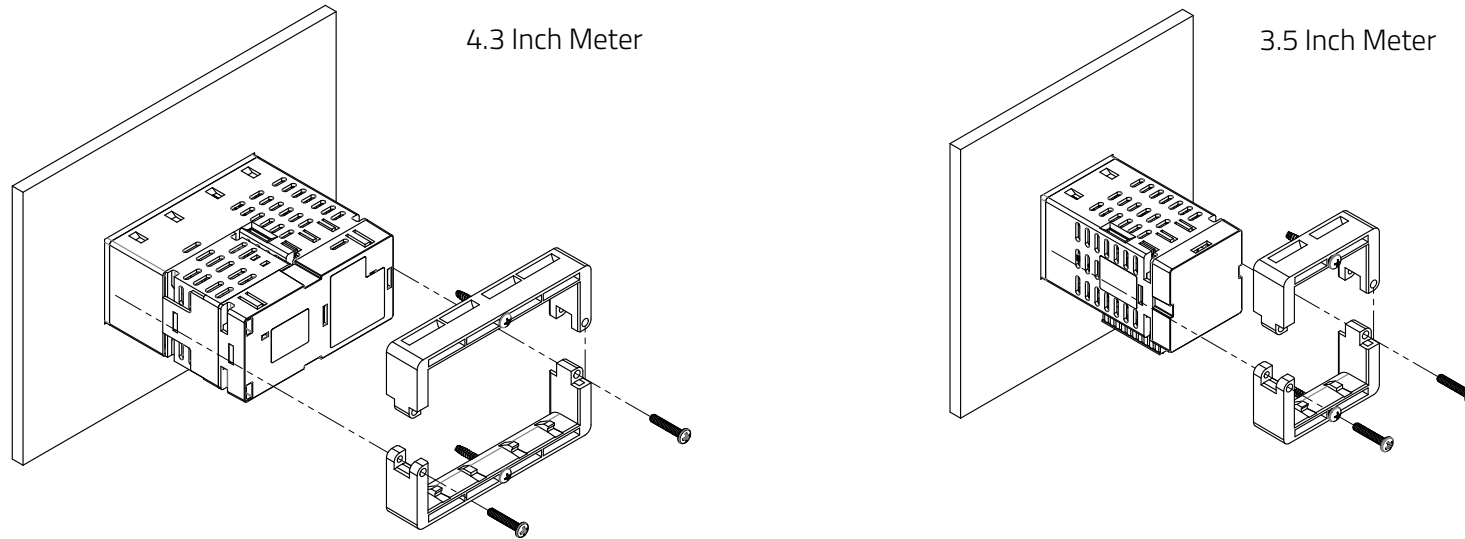

While holding the unit in place, place either the top or bottom panel latch on the rear of the unit closest to the panel cutout so that the tabs of the panel latch engage in the slots on the case. Repeat this process with the other half of the panel latch. Secure the latch with the panel mounting screws provided. To achieve a proper seal, tighten the latch screws evenly until the unit is snug in the panel (Torque to approximately 5 in-lbs [56 N-cm]). Do not over-tighten the screws.

Adding Modules



WARNING - Disconnect all power to the unit before installing or removing modules.

AVERTISSEMENT - Débranchez l'alimentation électrique de l'appareil avant d'installer ou de retirer des modules.

Installation of the product must comply with National Electrical Code (NEC), NFPA-70 or Canadian Electrical Code (CED) or any local regulation Authority.

To a 4.3 inch Host

1. To install a module on the tall side of a 4.3 inch host, align the latches of the module with the host case such that the backplane connector shroud on the module cover aligns with the backplane connector opening in the host case.
2. To install a module on the short side of a 4.3 inch host, rotate the module 180 degrees and align the latches on the host with the module case so that the I/O connector is facing downward.
3. Insert the host latches into the openings in the module case by slightly deflecting the latches inward.
4. Press the module into the host case evenly until the latches engage.
5. Install Module Locks between each module as shown by fully inserting the legs of the Module Locks into the slots in the case until the button on the Module Lock aligns with the hole provided in the case. Press fit the button into the hole. Repeat this installation between each module in your system to provide the most secure installation.
6. When you have finished adding modules, the rear cover should be installed in the same manner as the modules.



It is recommended that a relay module be installed in Module Position 1 only (shown below).

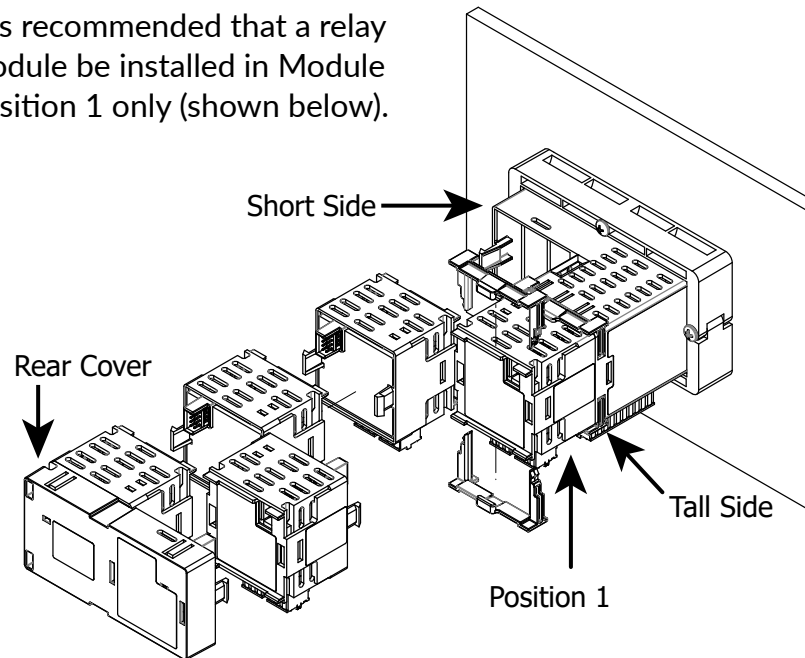

Note: When using the AC/DC module or the Spacer Module, they must be in the last position.

Module Installation Variations for 4.3 Inch (1/8 DIN) PM-50

The modules can be installed in various locations as shown below. Some installations require the Rear Interconnect Cover and Spacer Module (P/N – PMM000CP00800000). The cover connects the communication to the modules and may shorten the depth of the overall installation. A maximum of 5 modules may be connected.

Single Module Installation - Top View

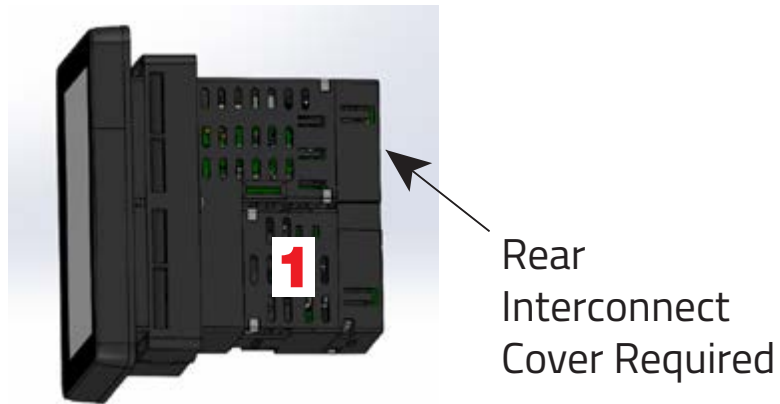

Dual Module Installation - Top View

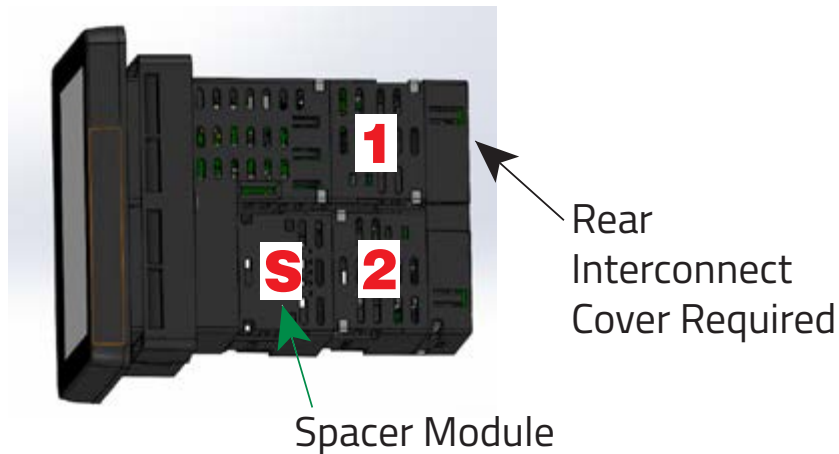

Five Module Installation - Top View

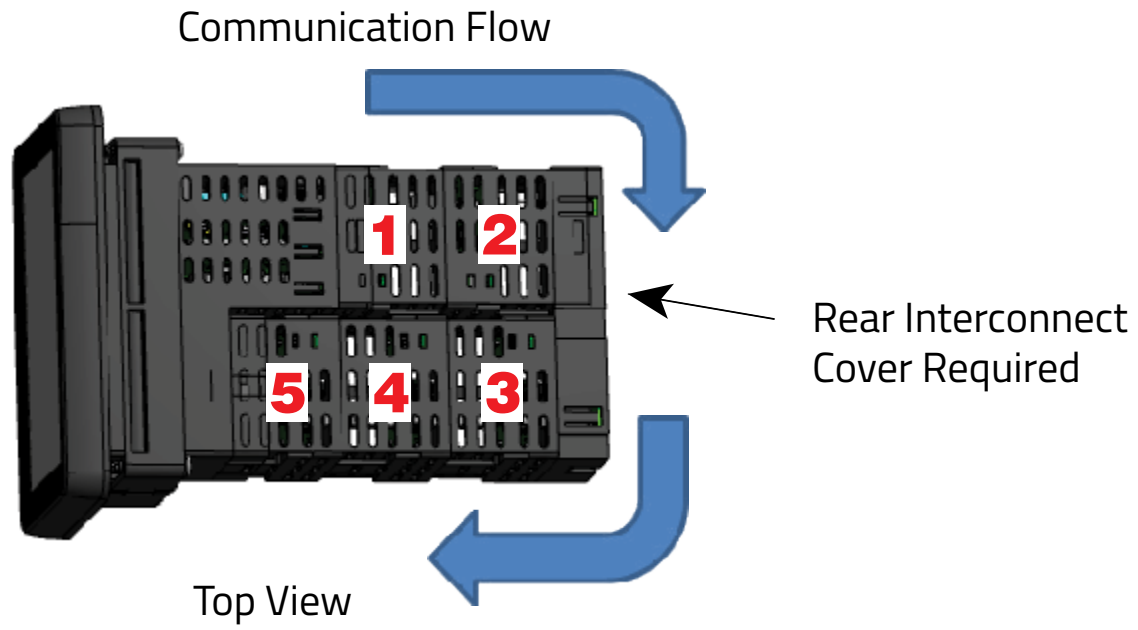

To a 3.5 inch Host

1. Align the latches of the module with the host case such that the backplane connector shroud on the module cover aligns with the backplane connector opening in the host case.
2. Insert the module latches into the openings in the host case by slightly deflecting the latches inward.
3. Press the module into the host case evenly until the latches engage.
4. Install Module Locks between each module as shown by fully inserting the legs of the Module Locks into the slots in the case until the button on the Module Lock aligns with the hole provided in the case. Press fit the button into the hole. Repeat this installation between each module in your system to provide the most secure installation.
5. When you have finished adding modules, the rear cover should be installed in the same manner as the modules.



It is recommended that a relay module be installed directly onto the back of the host (shown below), not on the back of any other module.

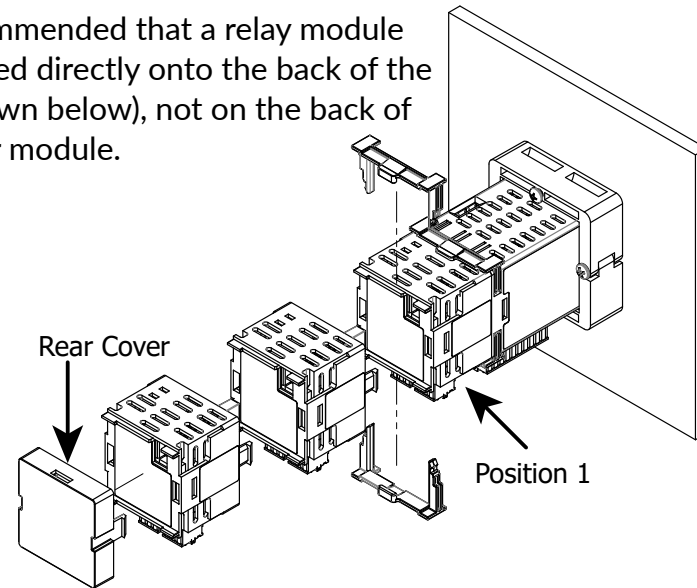

Note: When using the AC/DC module, it must be in the last position.

Wiring

All power, input and output (I/O) wiring must be in accordance with Class I, Division 2 wiring methods and in accordance with the authority having jurisdiction. Electrical connections are made via pluggable spring terminal blocks. It is recommended that the power supplied to the meter be protected by a fuse or circuit breaker.

When wiring the meter, refer to the label on the unit for pin-out numbering against those shown in the wiring drawings for proper wire position. Strip and connect the wire according to the terminal block specifications. Use a small screwdriver to press down on tab next to the terminal position to open the spring clamp. Insert the wire into the terminal position and then remove the screwdriver to engage the spring-clamp.

Power Wiring

Must use a Class 2 circuit according to National Electrical Code (NEC), NFPA-70 or Canadian Electrical Code (CEC), Part I, C22.1 or a Limited Power Supply (LPS) according to IEC/EN 60950-1 or Limited-energy circuit according to IEC/EN 61010-1.

DC Power

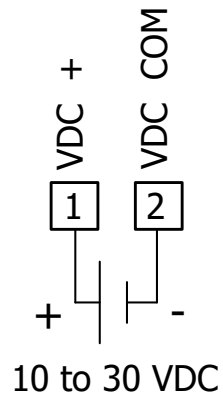

Ensure software configuration is set to correspond with your required application wiring.

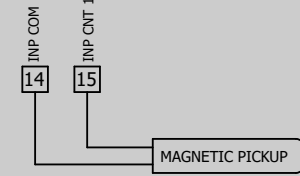
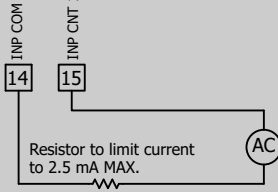
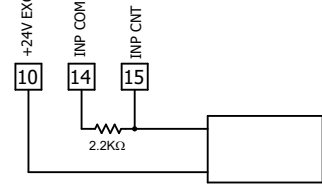
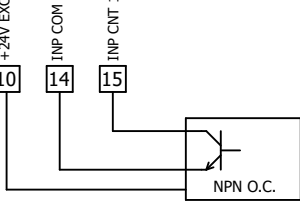
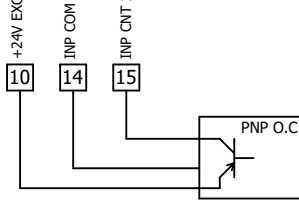
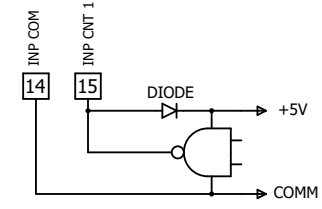
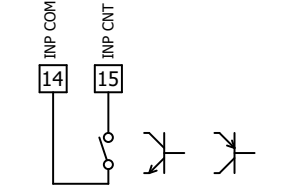
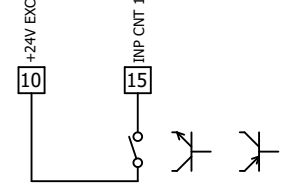
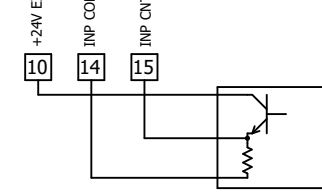
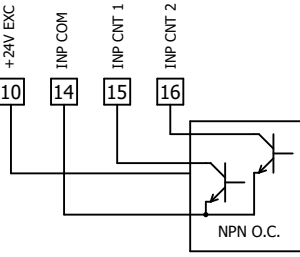
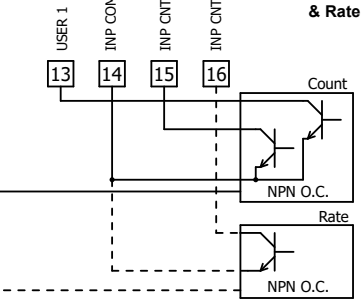
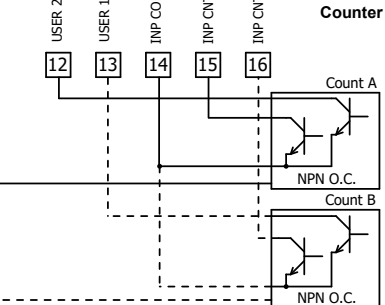
<p>Magnetic Pickup</p> <p>Input A</p>  <p>Software Configuration - Select Mag Mode</p>	<p>AC Inputs From Tach Generators, Etc.</p> <p>Input A</p>  <p>Resistor to limit current to 2.5 mA MAX.</p>	<p>Two Wire Proximity, Current Source</p> <p>Input A</p>  <p>2.2KΩ</p>
<p>Current Sinking Output</p> <p>Input A</p>  <p>NPN O.C.</p>	<p>Current Sourcing Output</p> <p>Input A</p>  <p>PNP O.C.</p>	<p>Interfacing With TTL</p> <p>Input A</p>  <p>DIODE</p> <p>+5V</p> <p>COMM</p>
<p>Switch or Isolated Transistor; Current Sink</p> <p>Input A</p> 	<p>Switch or Isolated Transistor; Current Source</p> <p>Input A</p> 	<p>Emitter Follower; Current Source</p> <p>Input A</p> 
<p>Current Sink Output; Quad/Direction</p> <p>Single Counter A</p>  <p>NPN O.C.</p>	<p>Current Sink Output; Quad/Direction</p> <p>Counter A & Rate B</p>  <p>Count</p> <p>Rate</p> <p>NPN O.C.</p> <p>NPN O.C.</p> <p>User Input Configured in Sink Position in Software</p>	<p>Current Sink Output; Quad/Direction</p> <p>Counter A & Counter B</p>  <p>Count A</p> <p>Count B</p> <p>NPN O.C.</p> <p>NPN O.C.</p> <p>User Input Configured in Sink Position in Software</p>

Shaded areas not recommended for counting applications.

USER INPUT WIRING

User Input terminal does not need to be wired in order to remain in the inactive state.

Sinking Logic

When the parameter is programmed to Low, check with device GUI option. The user inputs of the controller are internally pulled up to +3.3 V with 20 KΩ resistance. The input is active when it is pulled low (<0.9 V).

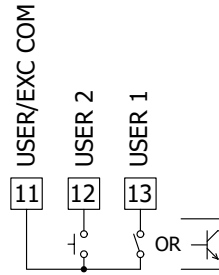

Sourcing Logic

When the parameter is programmed to High, check with device GUI option. The user inputs of the controller are internally pulled down to 0 V with 20 KΩ resistance. The input is active when a voltage greater than 2.4 VDC is applied.

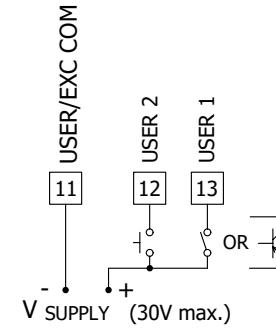

ON-BOARD DUAL SSR WIRING

The SSR outputs require meter configuration to address their functionality. The drawings below illustrate the wiring for each option.

Sinking Mode

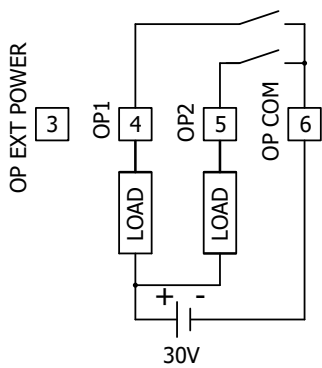

100 mA PER OUTPUT
SSR OUTPUTS SINKING MODE

Sourcing Mode

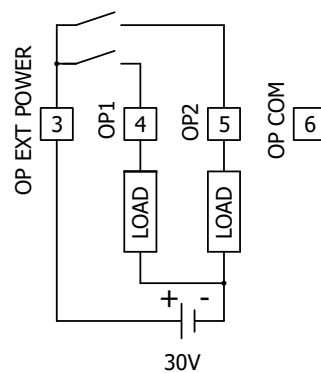

100 mA PER OUTPUT
SSR OUTPUTS SOURCING MODE

RS485/MODBUS

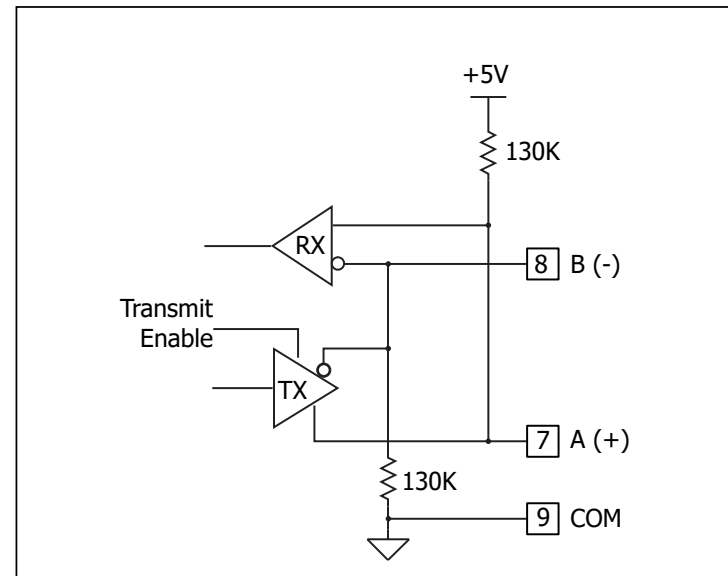

Service and Support Information

Service Information

We sincerely hope that you never experience a problem with any of our products. If you do need service, call Red Lion at 1-877-432-9908 for Technical Support. A trained specialist will help you determine the source of the problem. Many problems are easily resolved with a single phone call. If it is necessary to return a unit to us, an RO (Repair Order) can be obtained on the Red Lion website.

Red Lion tracks the flow of returned material with our RO system to ensure speedy service. You must include this RO number on the outside of the box so that your return can be processed immediately.

Be sure to have your original purchase order number and date purchased available.

We suggest that you give us a repair purchase order number in case the repair is not covered under our warranty. You will not be billed if the repair is covered under warranty.

Please supply us with as many details about the problem as you can. The information you supply will be written on the RO form and supplied to the repair department before your unit arrives. This helps us to provide you with the best service, in the fastest manner. Repairs are completed as soon as possible. If you need a quicker turnaround, ship the unit to us by air freight. We give priority service to equipment that arrives by overnight delivery.

We apologize for any inconvenience that the need for repair may cause you. We hope that our rapid service meets your needs. If you have any suggestions to help us improve our service, please give us a call. We appreciate your ideas and will respond to them.

Product Support

Technical Support:

Inside US: +1 (877) 432-9908

Outside US: +1 (717) 767-6511

Support: support.redlion.net

Hours: 8:00 am to 6:00 pm EST

Red Lion Controls

20 Willow Springs Circle

York, PA 17406

Website: www.redlion.net

LIMITED WARRANTY

(a) Red Lion Controls Inc. (the "Company") warrants that all Products shall be free from defects in material and workmanship under normal use for the period of time provided in "Statement of Warranty Periods" (available at www.redlion.net) current at the time of shipment of the Products (the "Warranty Period"). **EXCEPT FOR THE ABOVE-STATED WARRANTY, COMPANY MAKES NO WARRANTY WHATSOEVER WITH RESPECT TO THE PRODUCTS, INCLUDING ANY (A) WARRANTY OF MERCHANTABILITY; (B) WARRANTY OF FITNESS FOR A PARTICULAR PURPOSE; OR (C) WARRANTY AGAINST INFRINGEMENT OF INTELLECTUAL PROPERTY RIGHTS OF A THIRD PARTY; WHETHER EXPRESS OR IMPLIED BY LAW, COURSE OF DEALING, COURSE OF PERFORMANCE, USAGE OF TRADE OR OTHERWISE.** Customer shall be responsible for determining that a Product is suitable for Customer's use and that such use complies with any applicable local, state or federal law.

(b) The Company shall not be liable for a breach of the warranty set forth in paragraph (a) if (i) the defect is a result of Customer's failure to store, install, commission or maintain the Product according to specifications; (ii) Customer alters or repairs such Product without the prior written consent of Company.

(c) Subject to paragraph (b), with respect to any such Product during the Warranty Period, Company shall, in its sole discretion, either (i) repair or replace the Product; or (ii) credit or refund the price of Product provided that, if Company so requests, Customer shall, at Company's expense, return such Product to Company.

(d) **THE REMEDIES SET FORTH IN PARAGRAPH (c) SHALL BE THE CUSTOMER'S SOLE AND EXCLUSIVE REMEDY AND COMPANY'S ENTIRE LIABILITY FOR ANY BREACH OF THE LIMITED WARRANTY SET FORTH IN PARAGRAPH (a).**

BY INSTALLING THIS PRODUCT, YOU AGREE TO THE TERMS OF THIS WARRANTY, AS WELL AS ALL OTHER DISCLAIMERS AND WARRANTIES IN THIS DOCUMENT.